



Quantum physics with CubeSats

13th Annual CubeSat Developers' Workshop

SSC16-WK-01

LOGAN, UTAH, USA (08/07/2016)

Rakhitha Chandrasekara

Quantum Information



photons

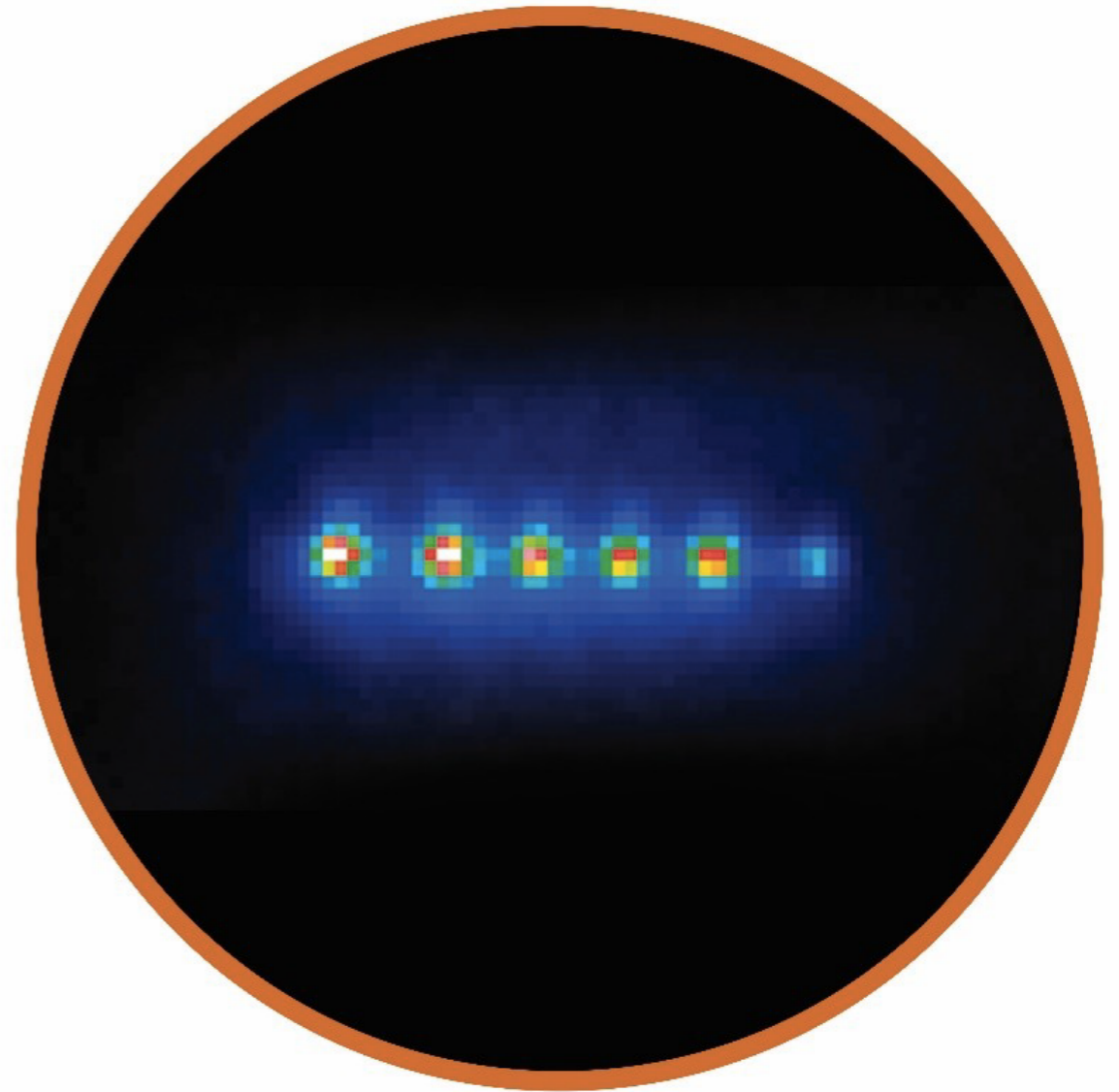

atoms

Quantum Key Distribution (QKD)

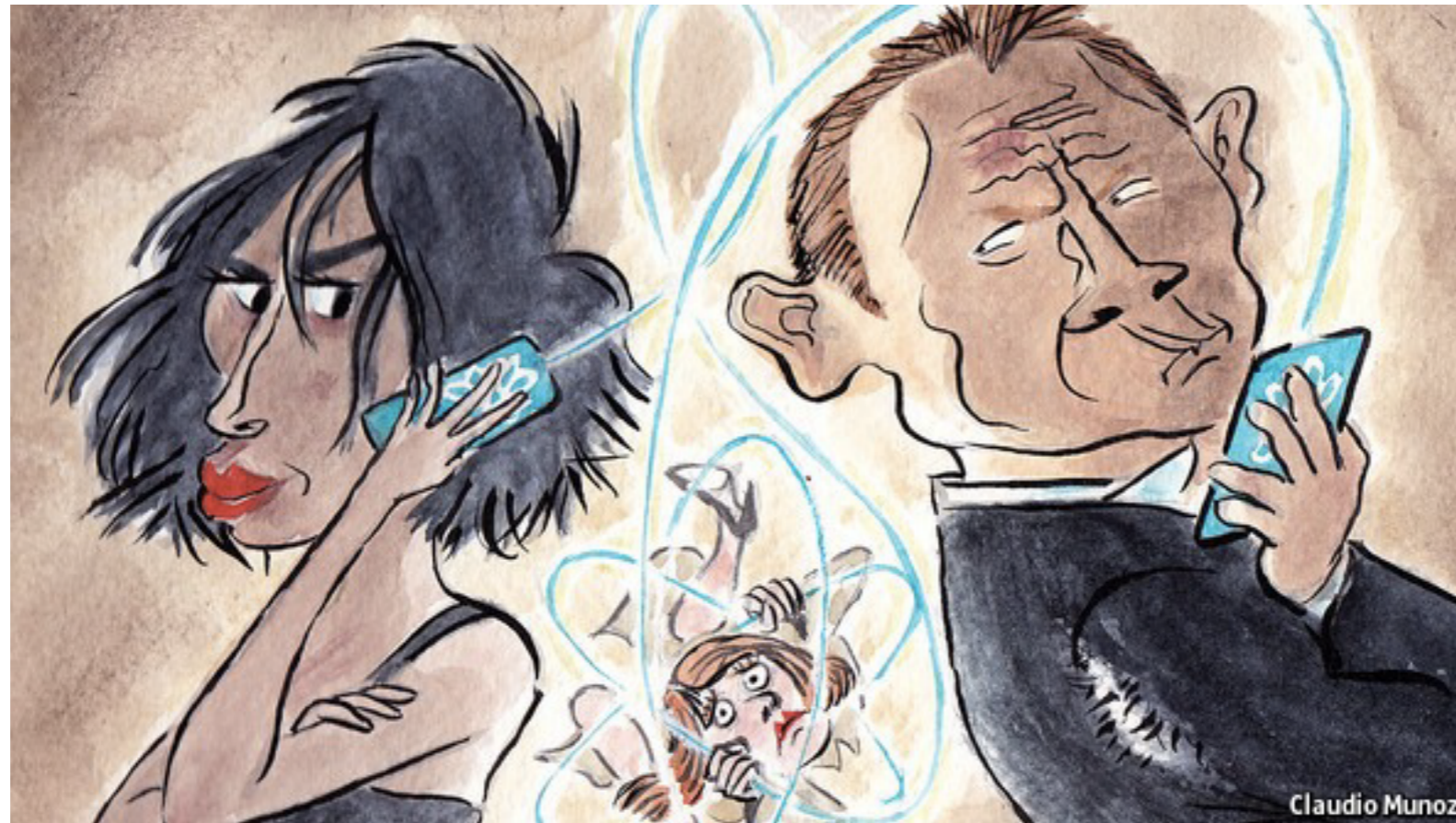
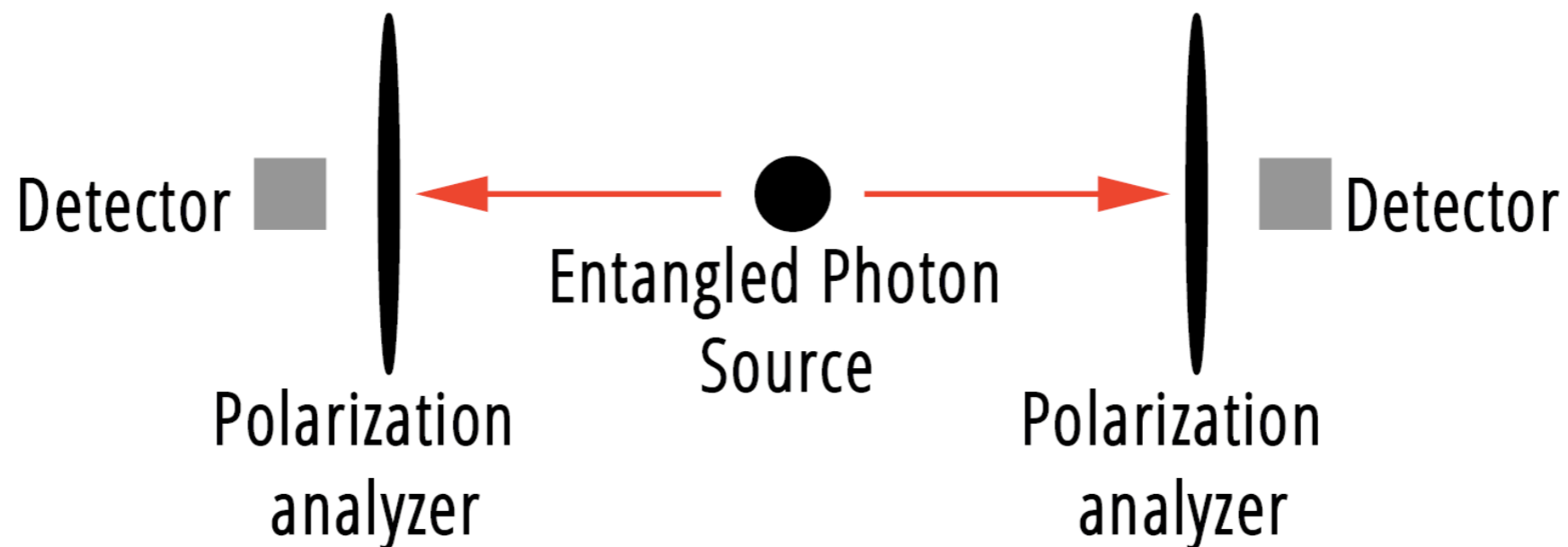

Image : The Solace of Quantum, The Economist, May 2013



Global QKD



Global QKD Proposals

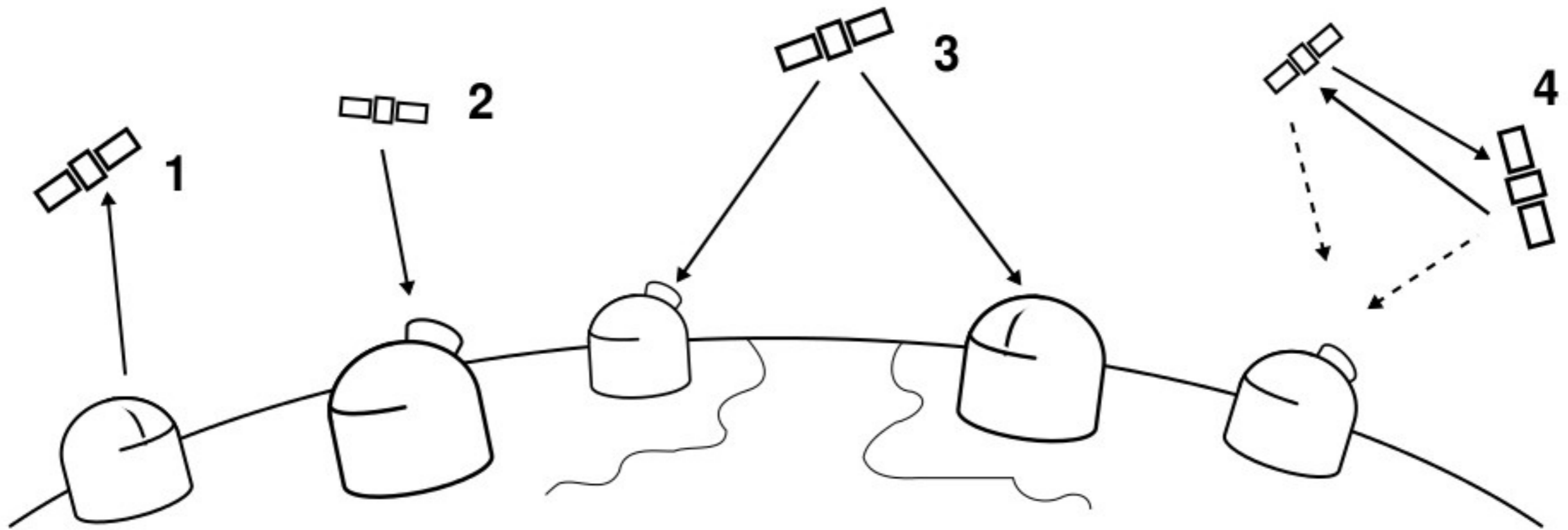

A QKD precursor

A QKD precursor

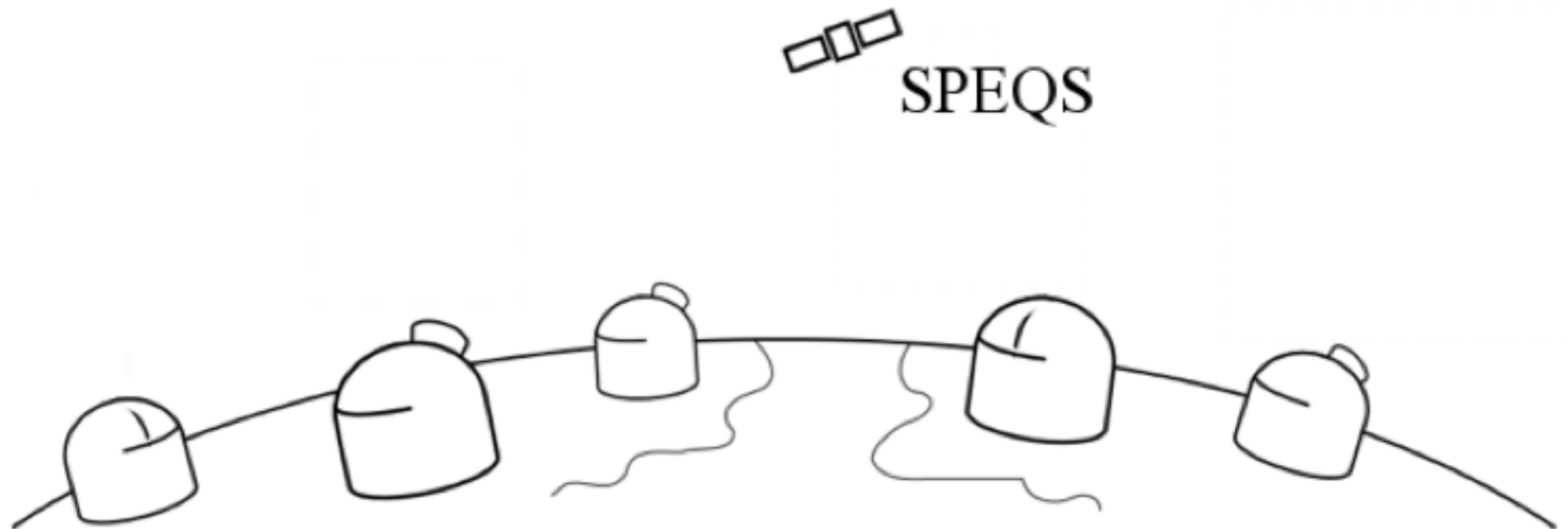

A QKD precursor

Small
Photon
Entangling
Quantum
System

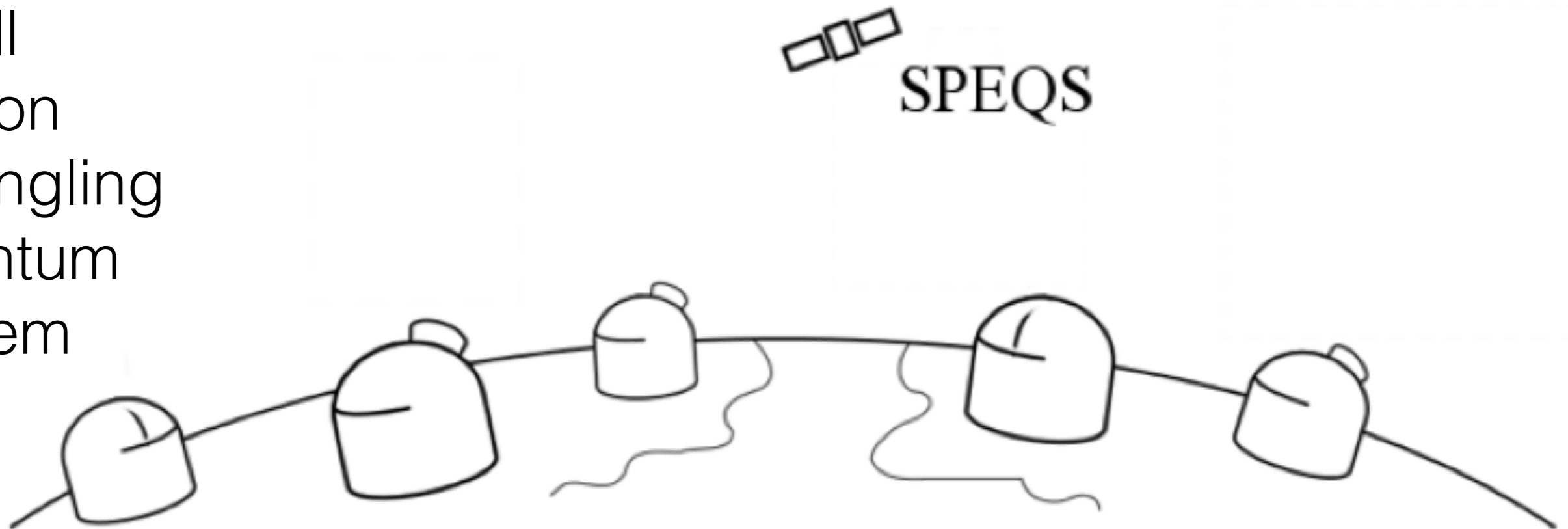

A QKD precursor

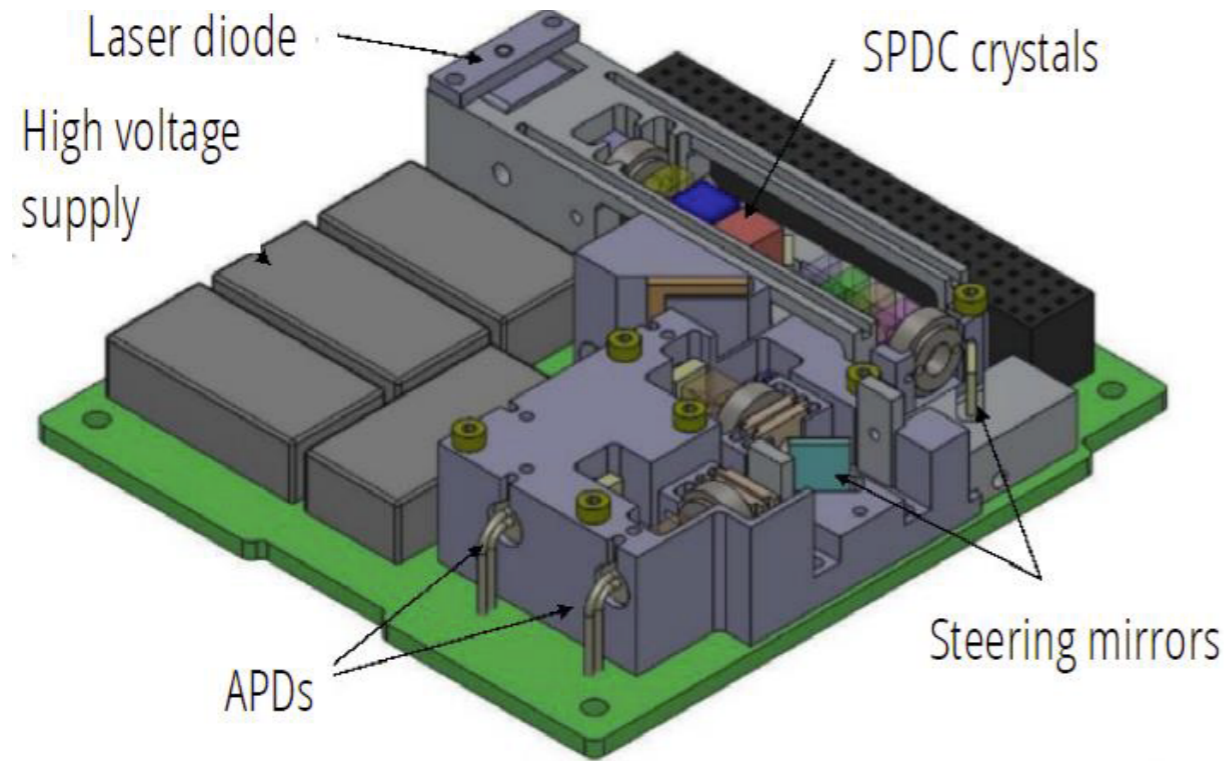

Small
Photon
Entangling
Quantum
System

SPEQS

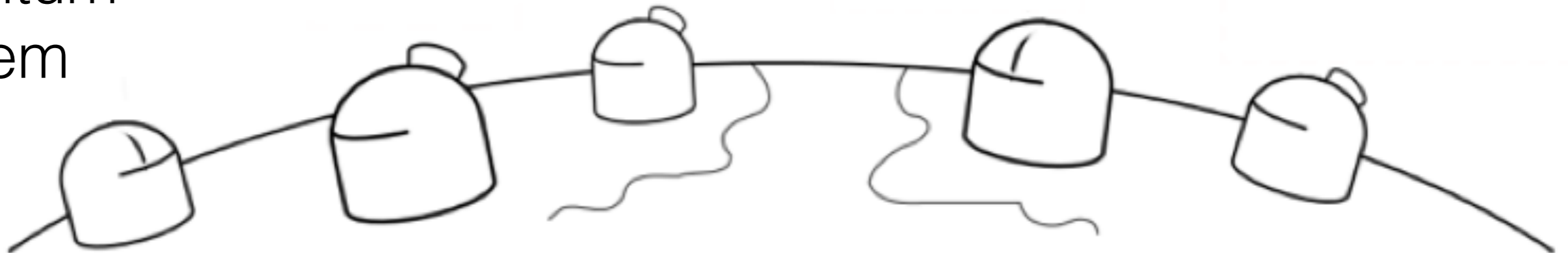

A QKD precursor

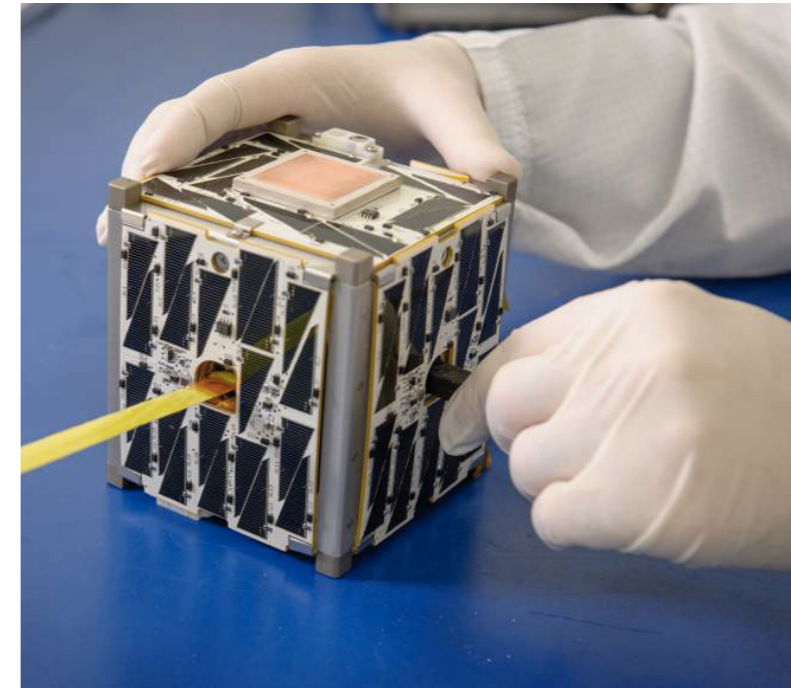
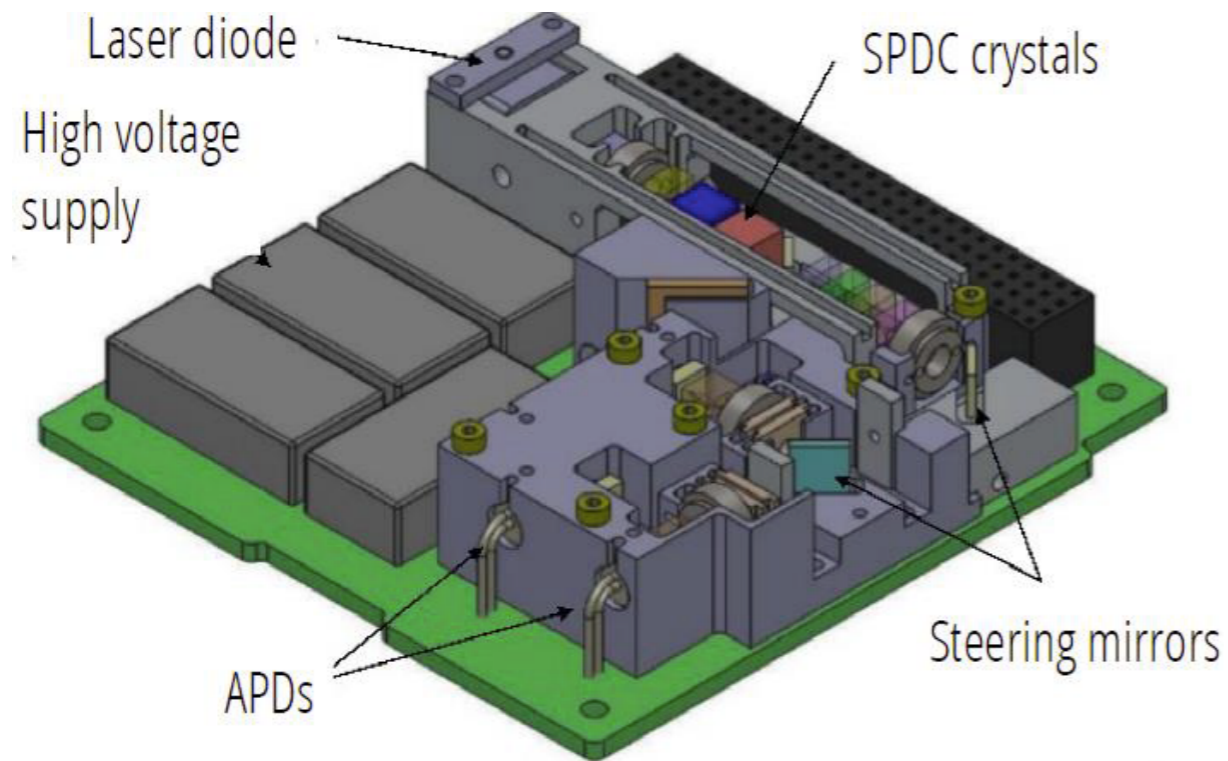

Small
Photon
Entangling
Quantum
System

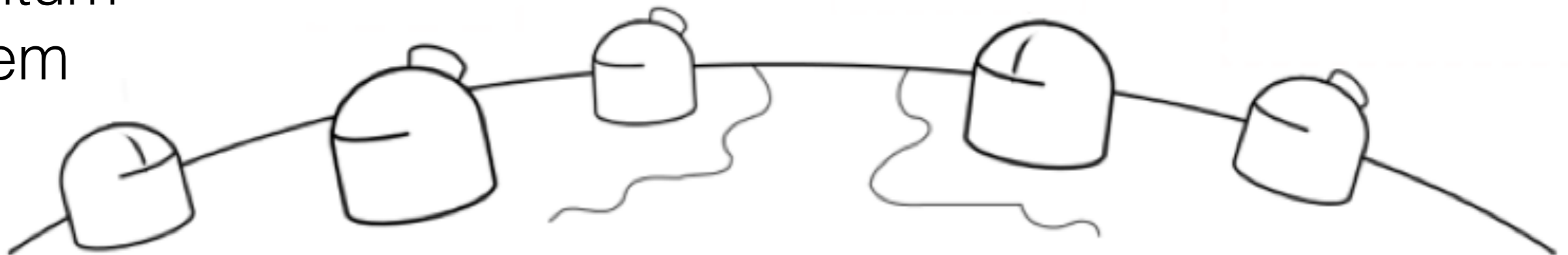

SPEQS

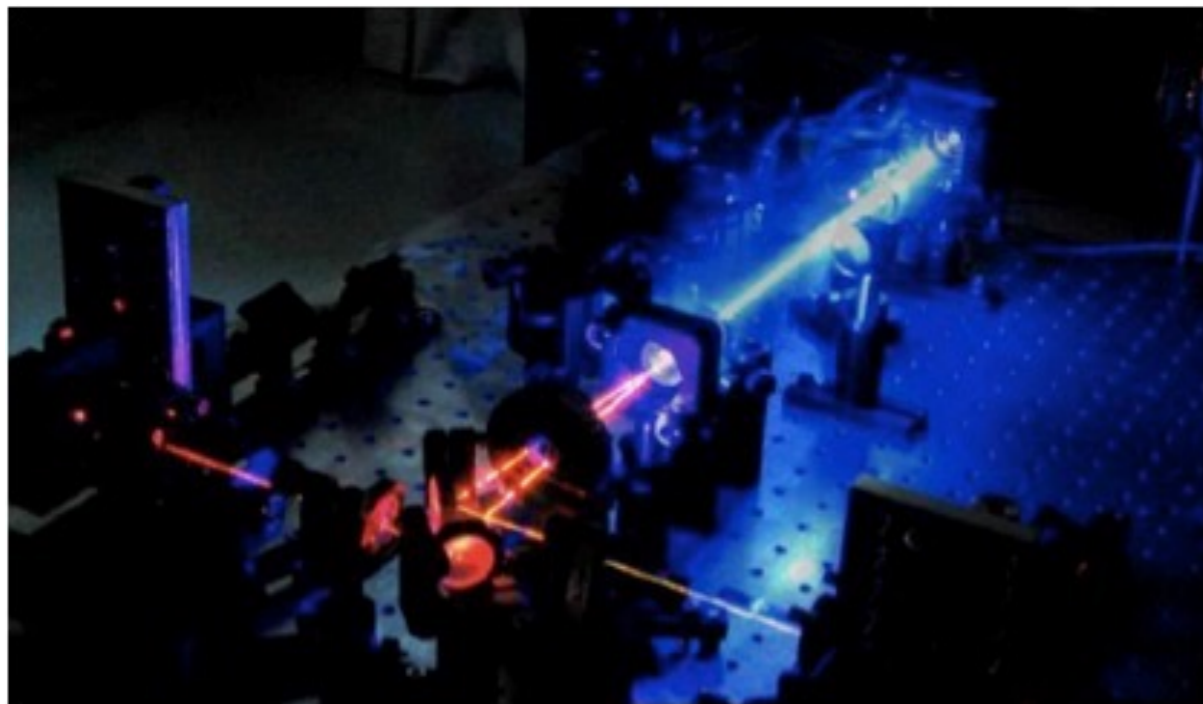

Entangled sources & Cubesats

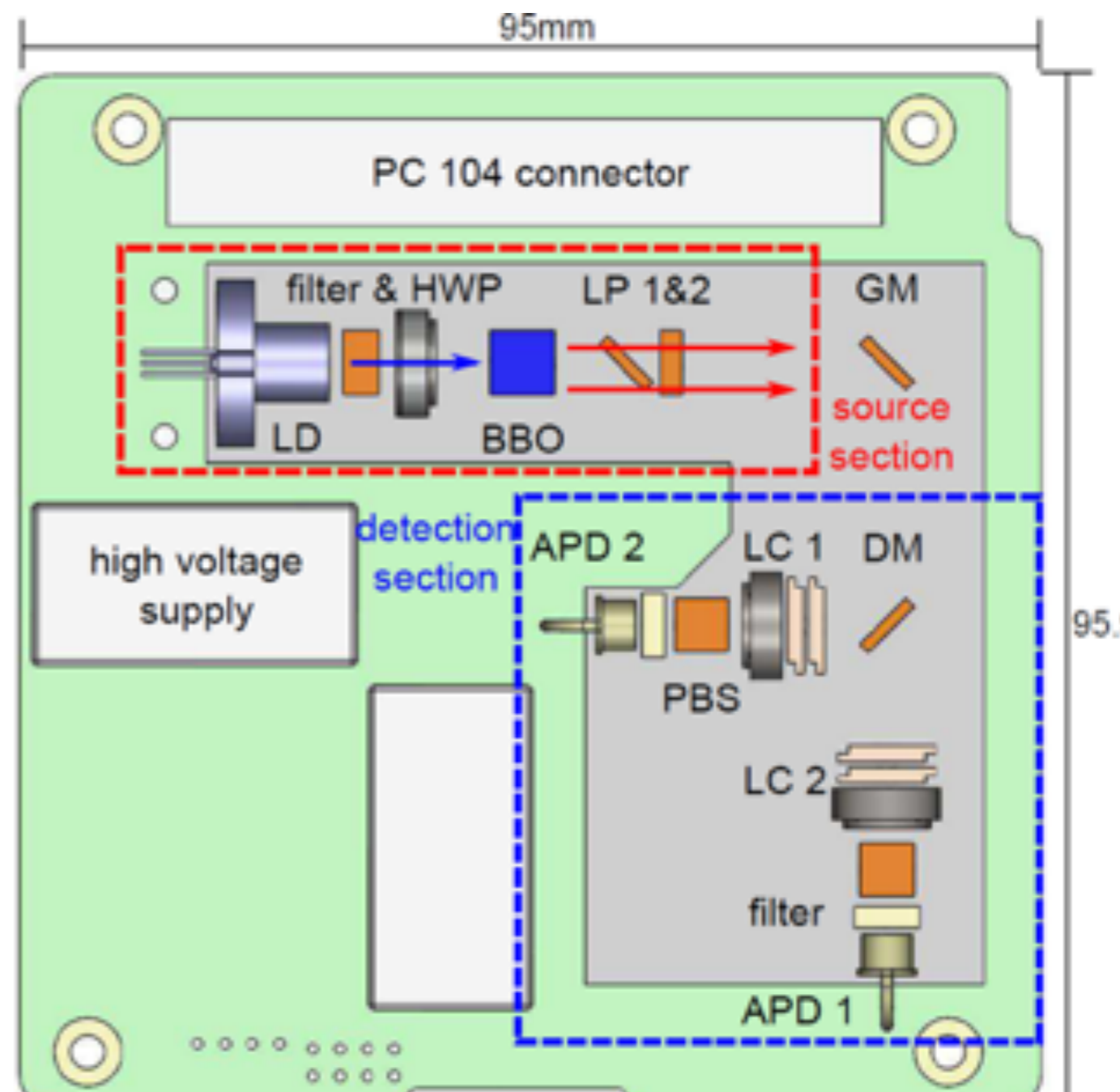

SWAP



The Small Source

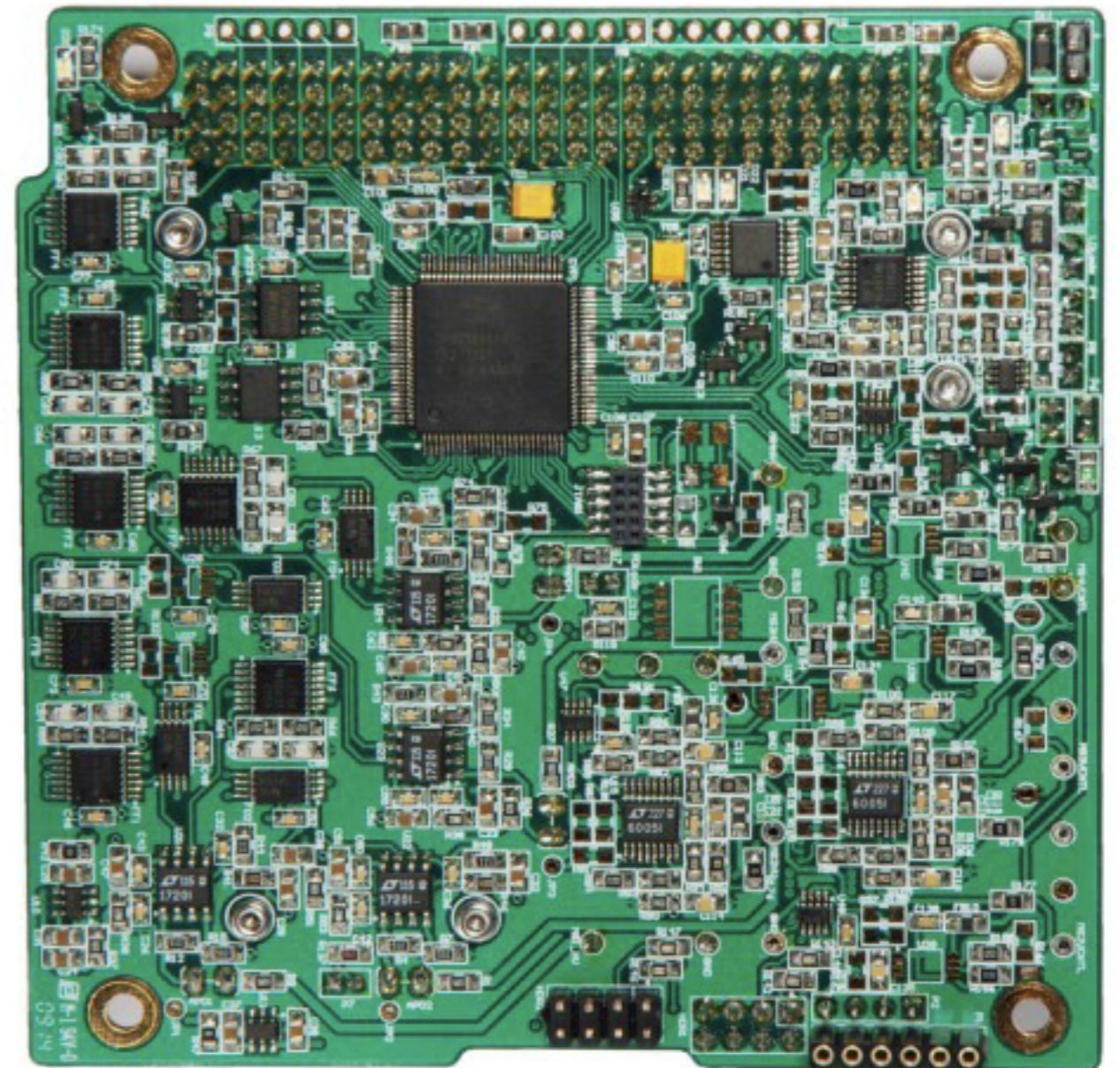
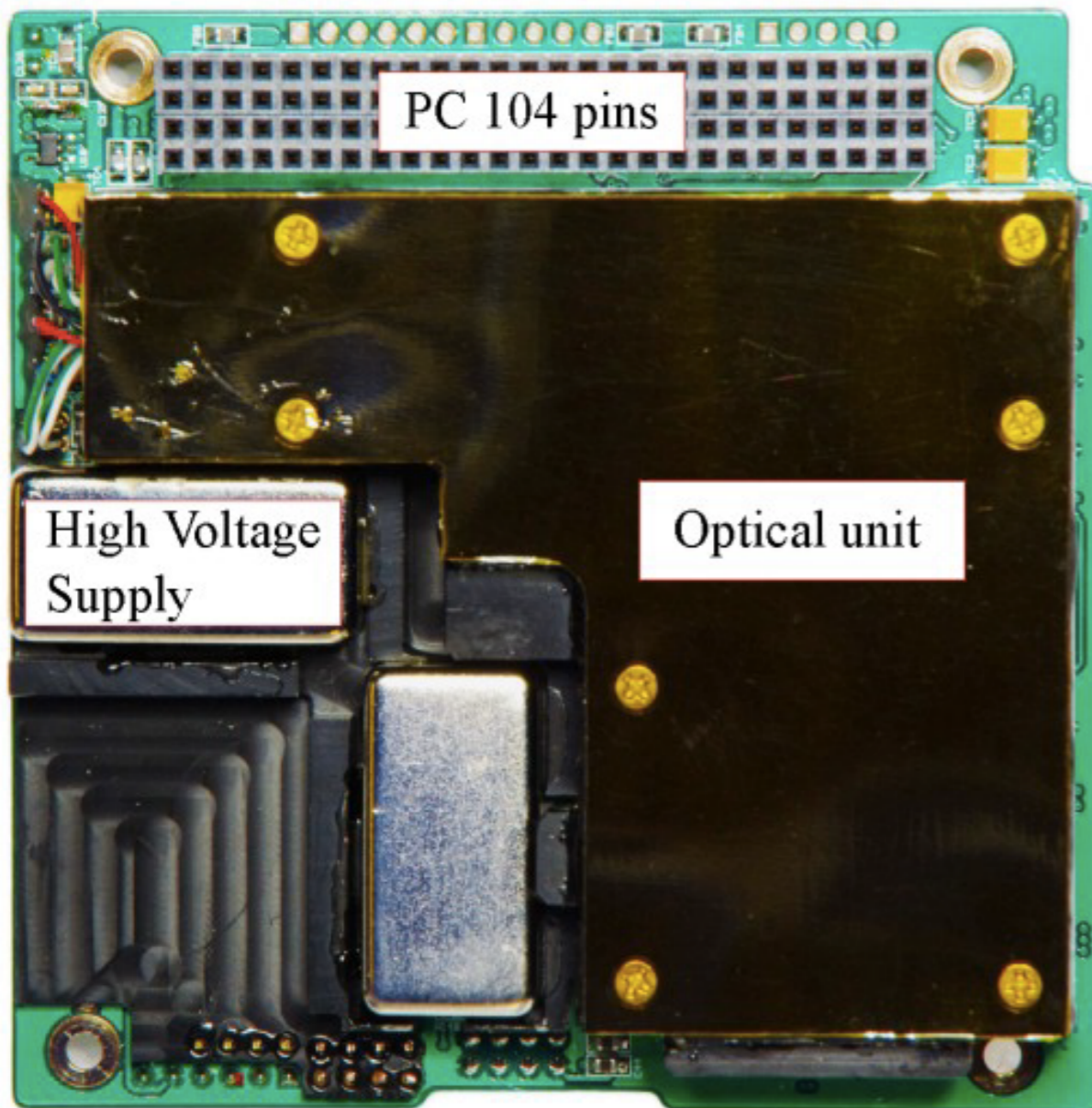

SPEQS Space Heritage

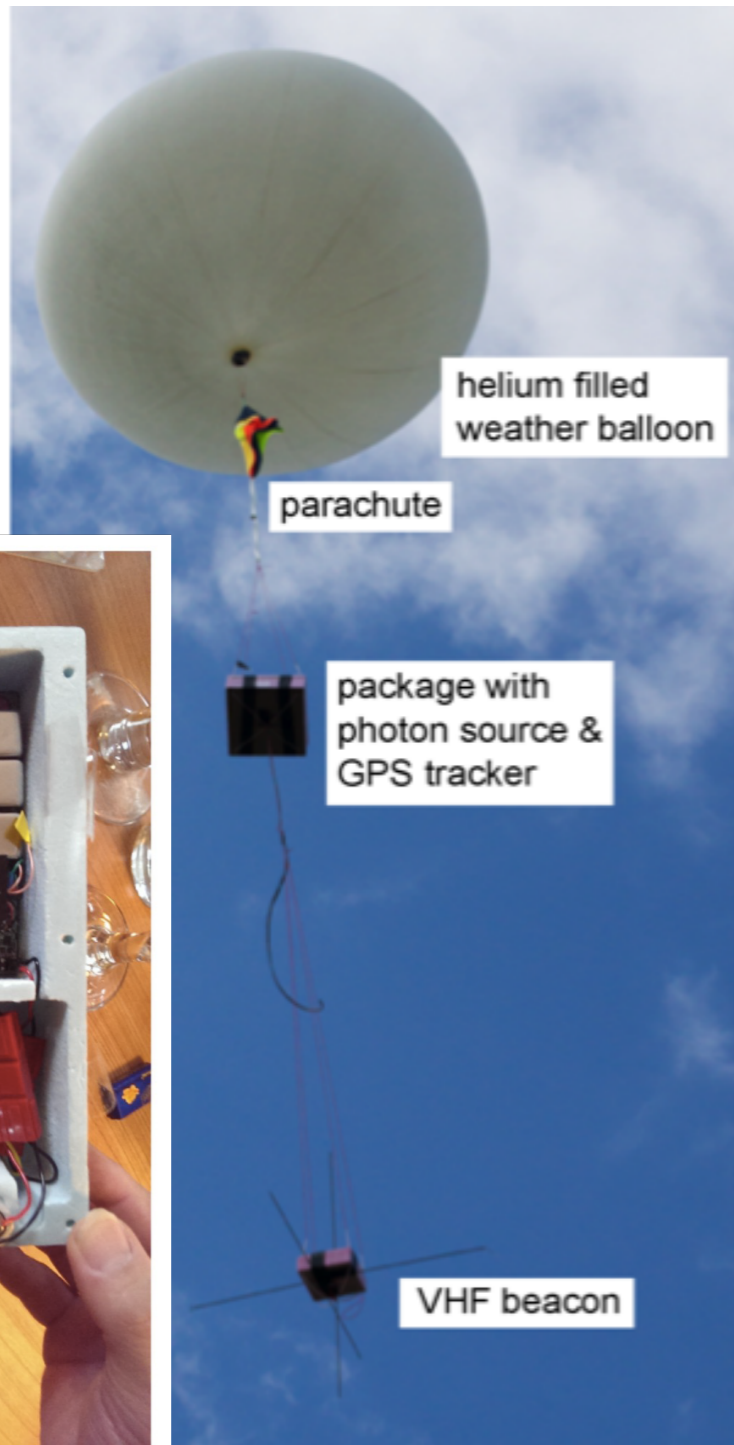

2013

Scientific Reports, vol. 4,6366 (2014)

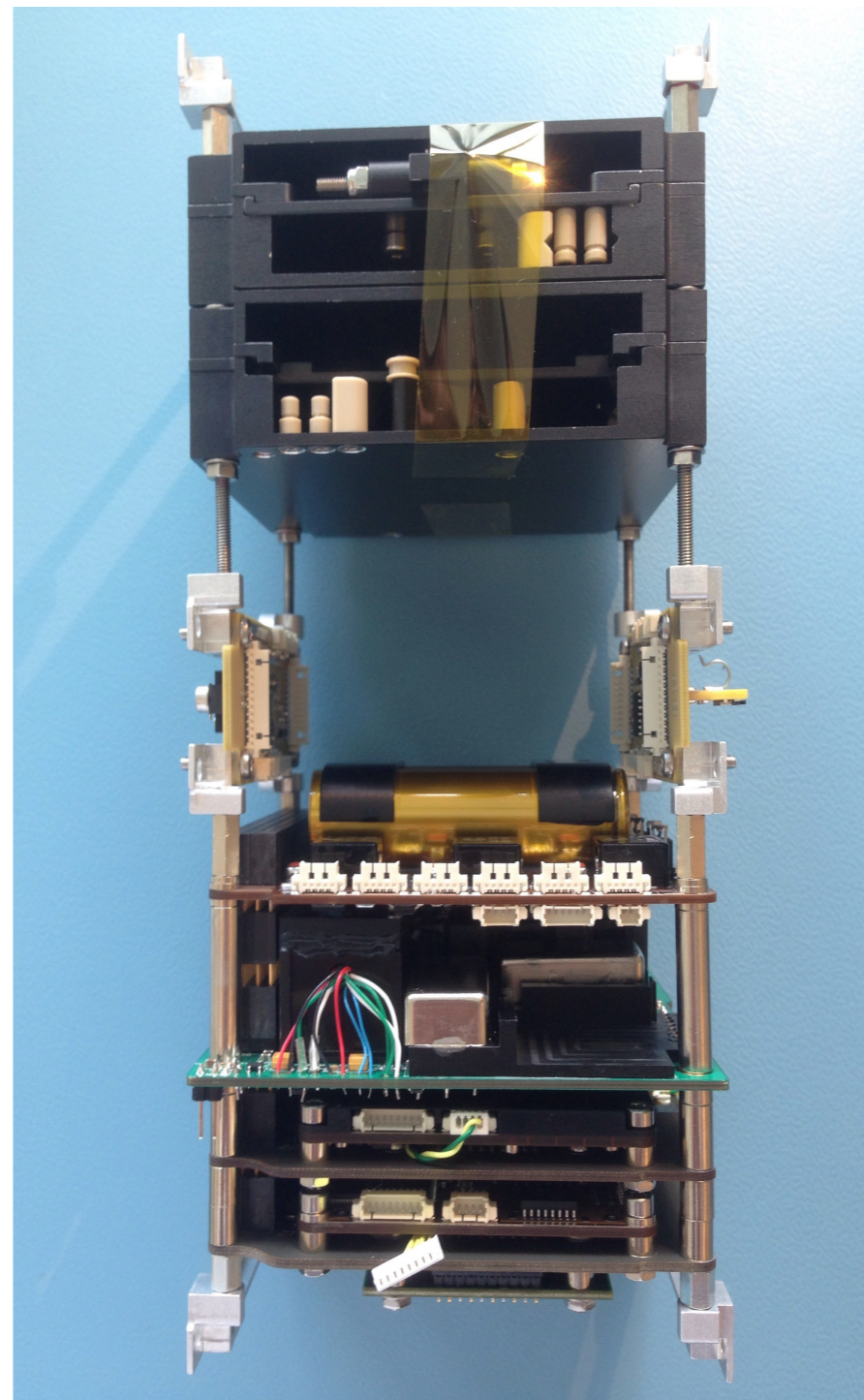
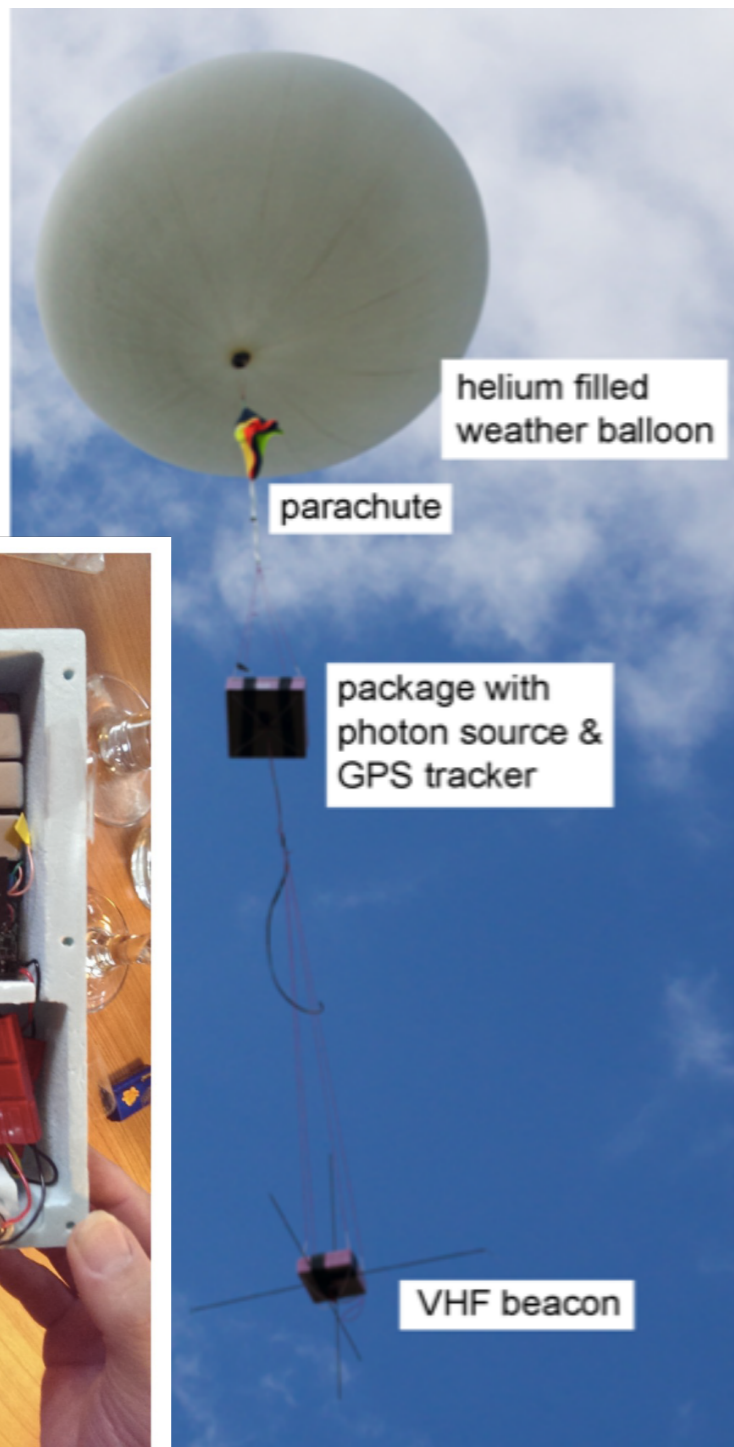

Photo courtesy of GomSpace APS

Sci. Rep. 6, 25603, 2016

SPEQS Space Heritage



2013

Scientific Reports, vol. 4,6366 (2014)

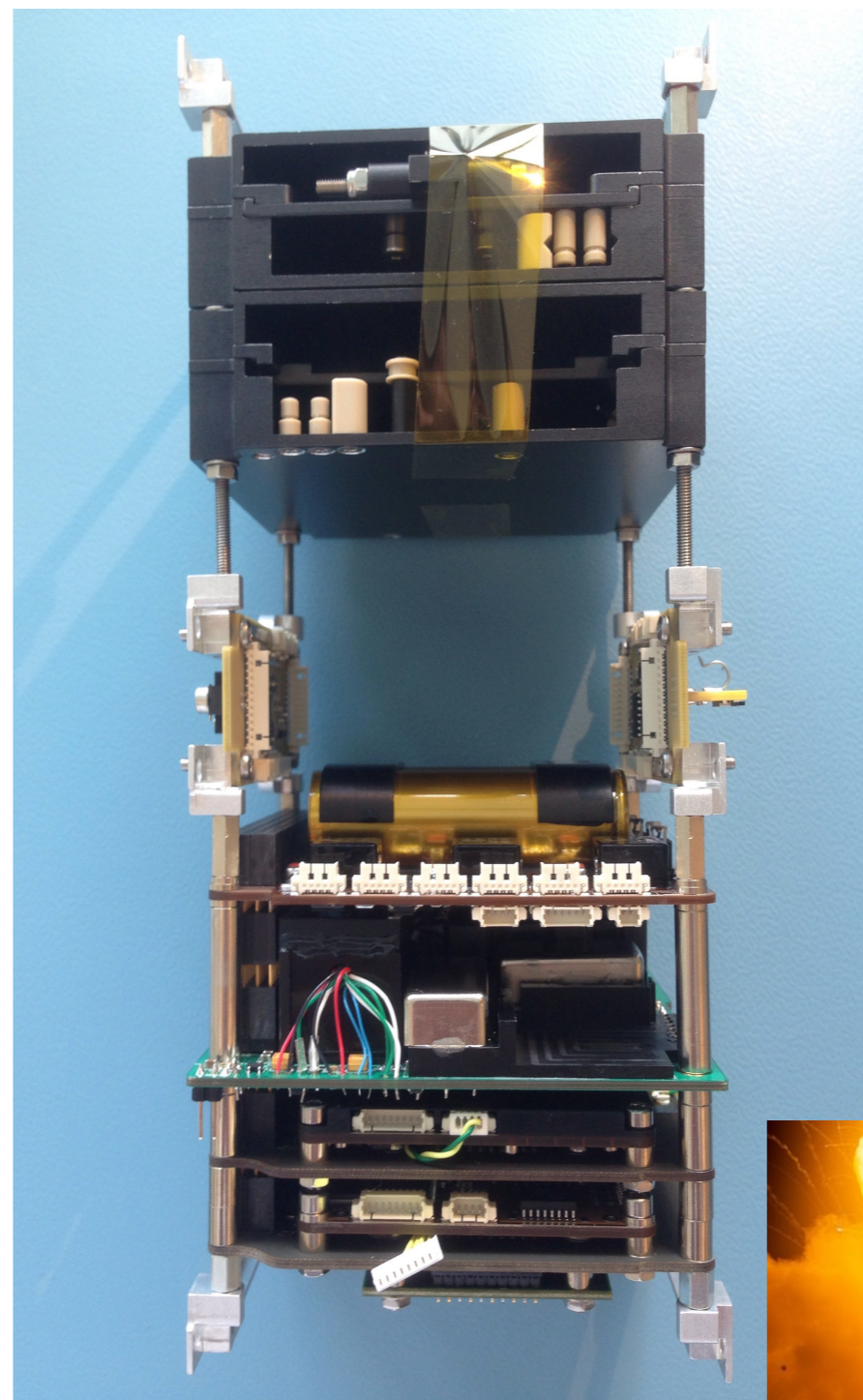
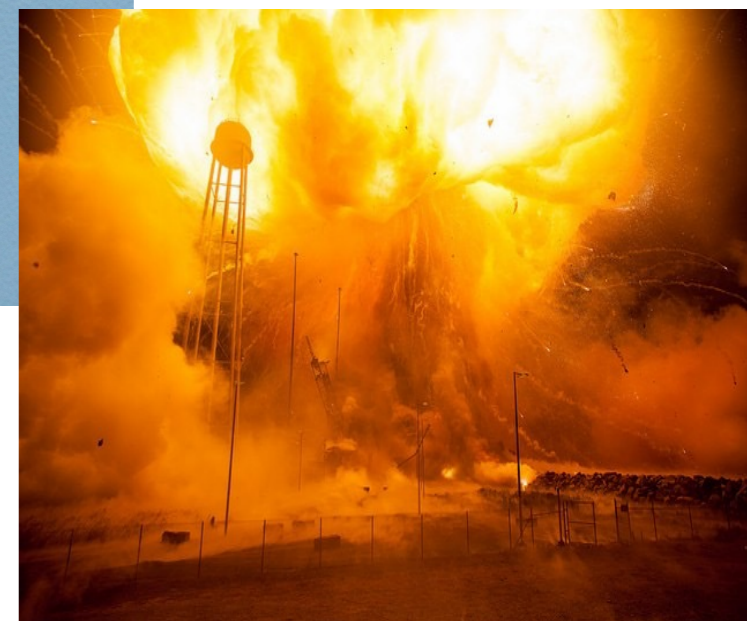
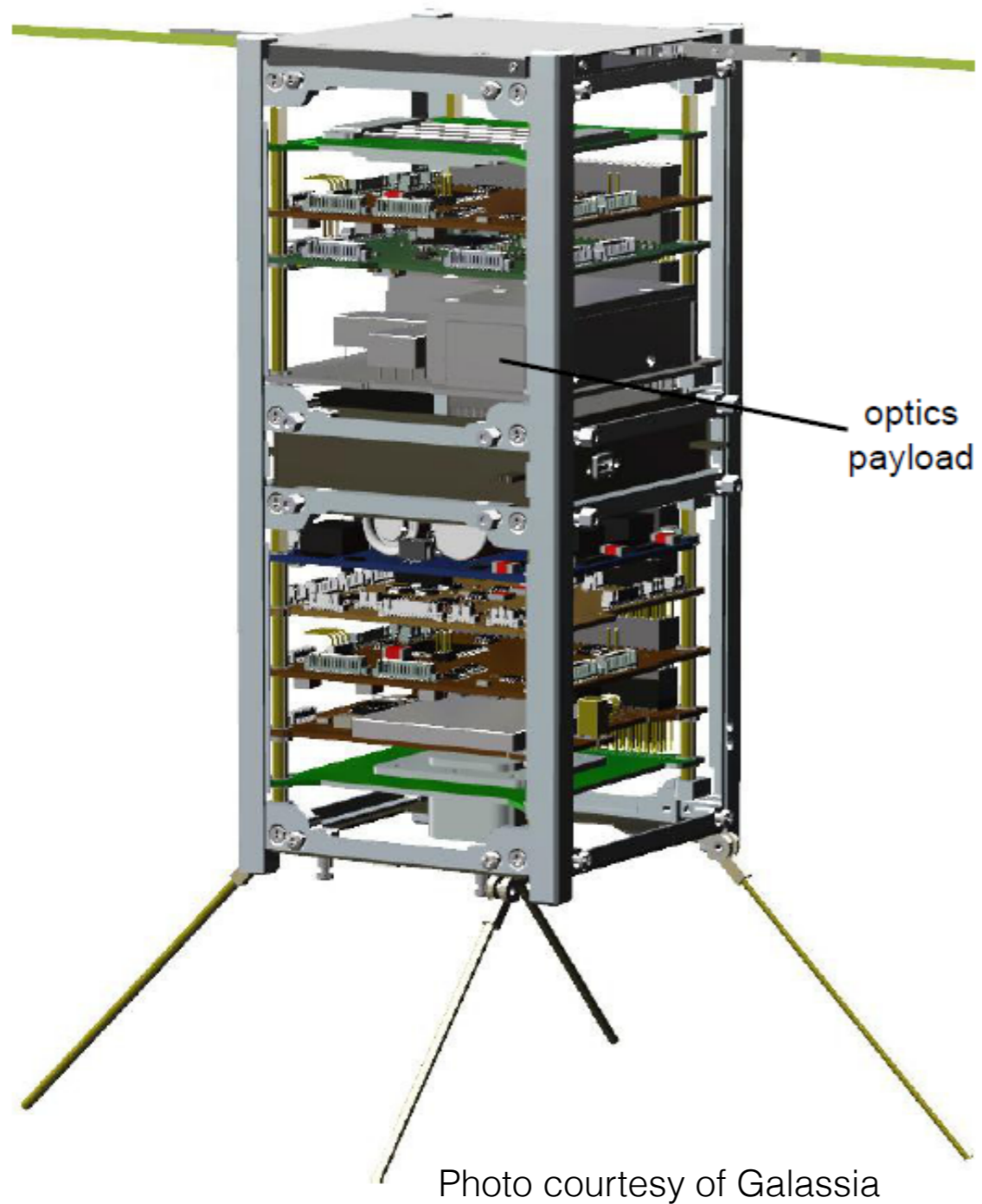

Photo courtesy of GomSpace APS

Sci. Rep. 6, 25603, 2016



Galassia Mission - 2015



Galassia Mission - 2015

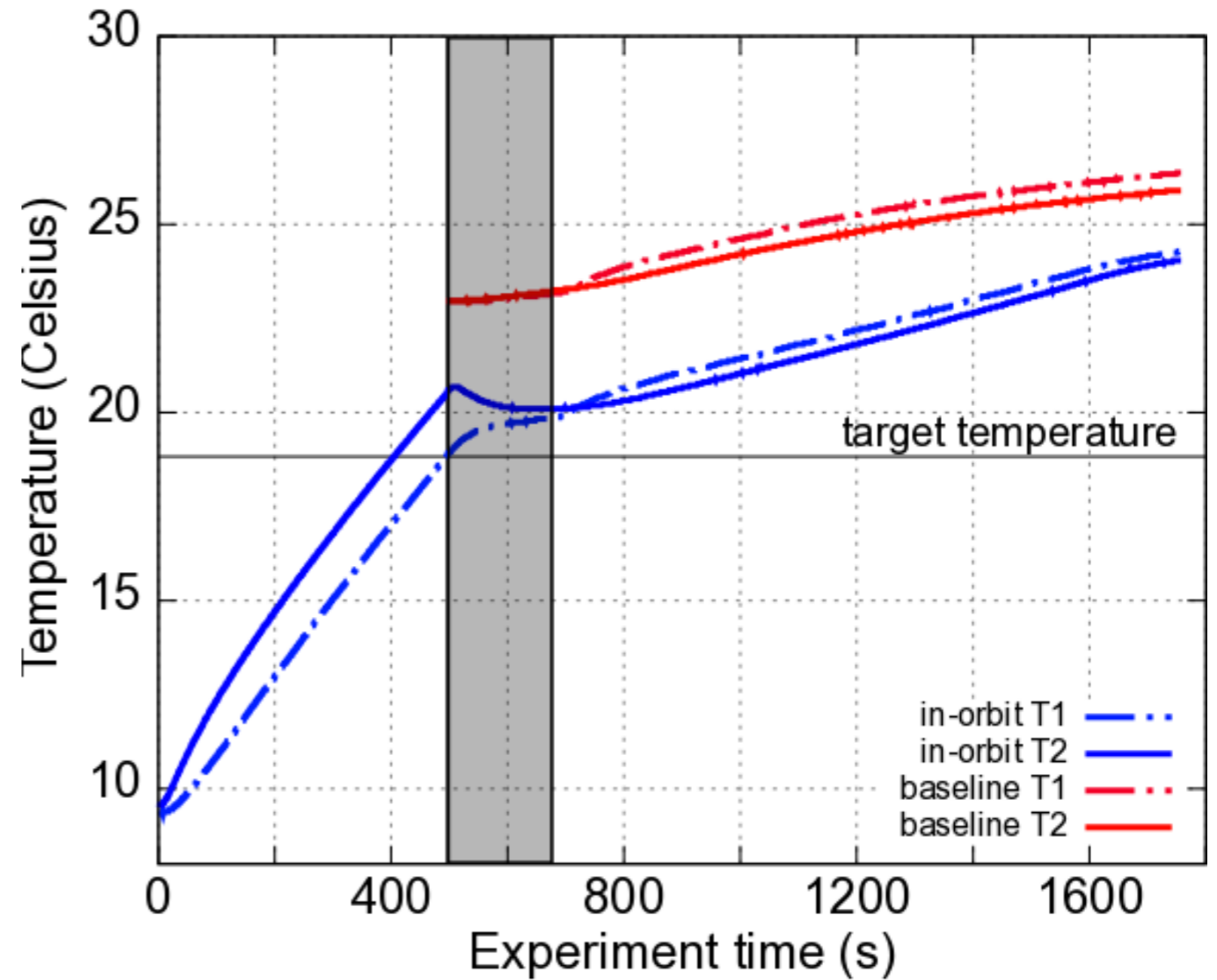

In orbit SPEQS performance

Detector dark counts

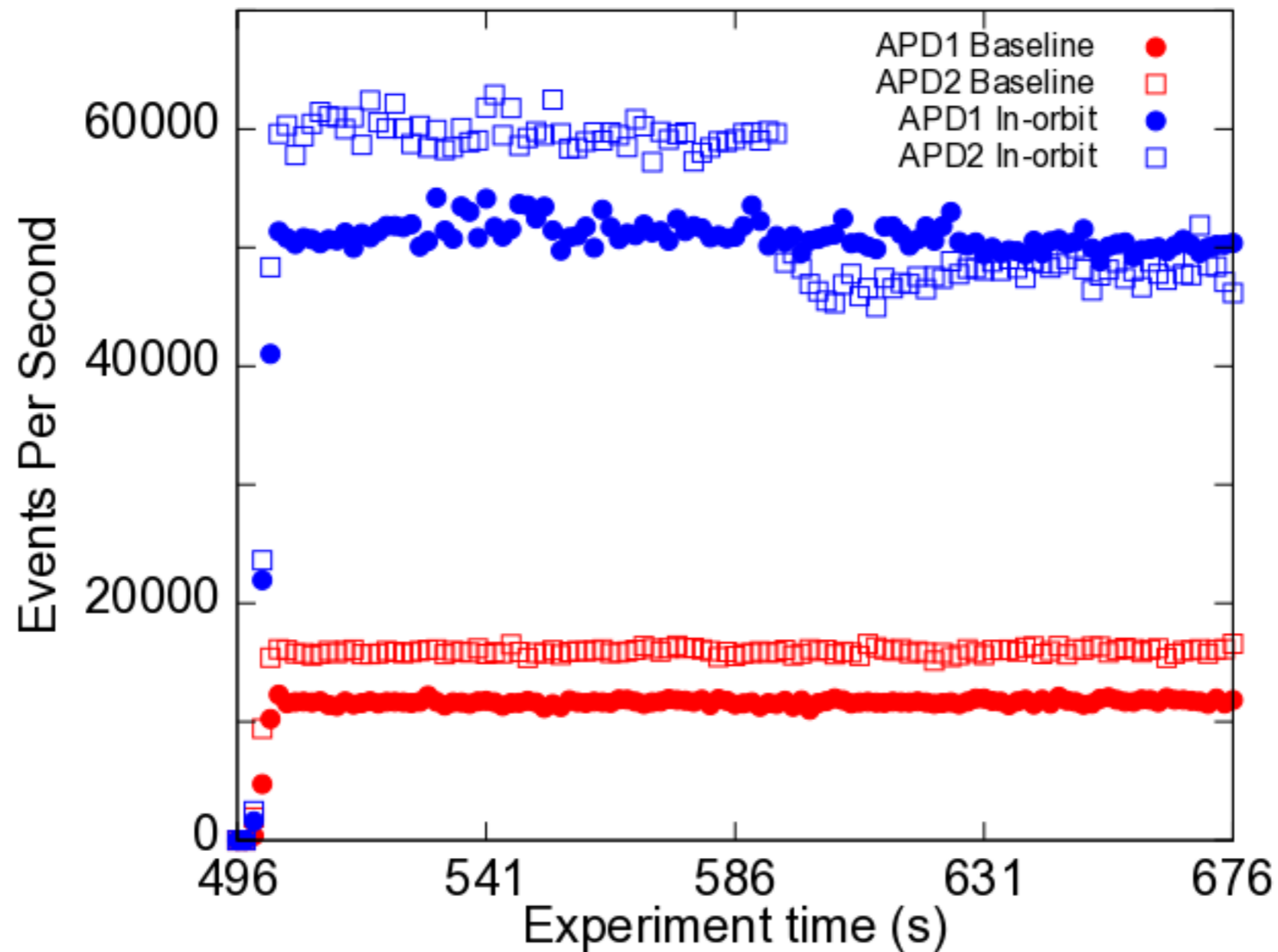

In orbit correlations

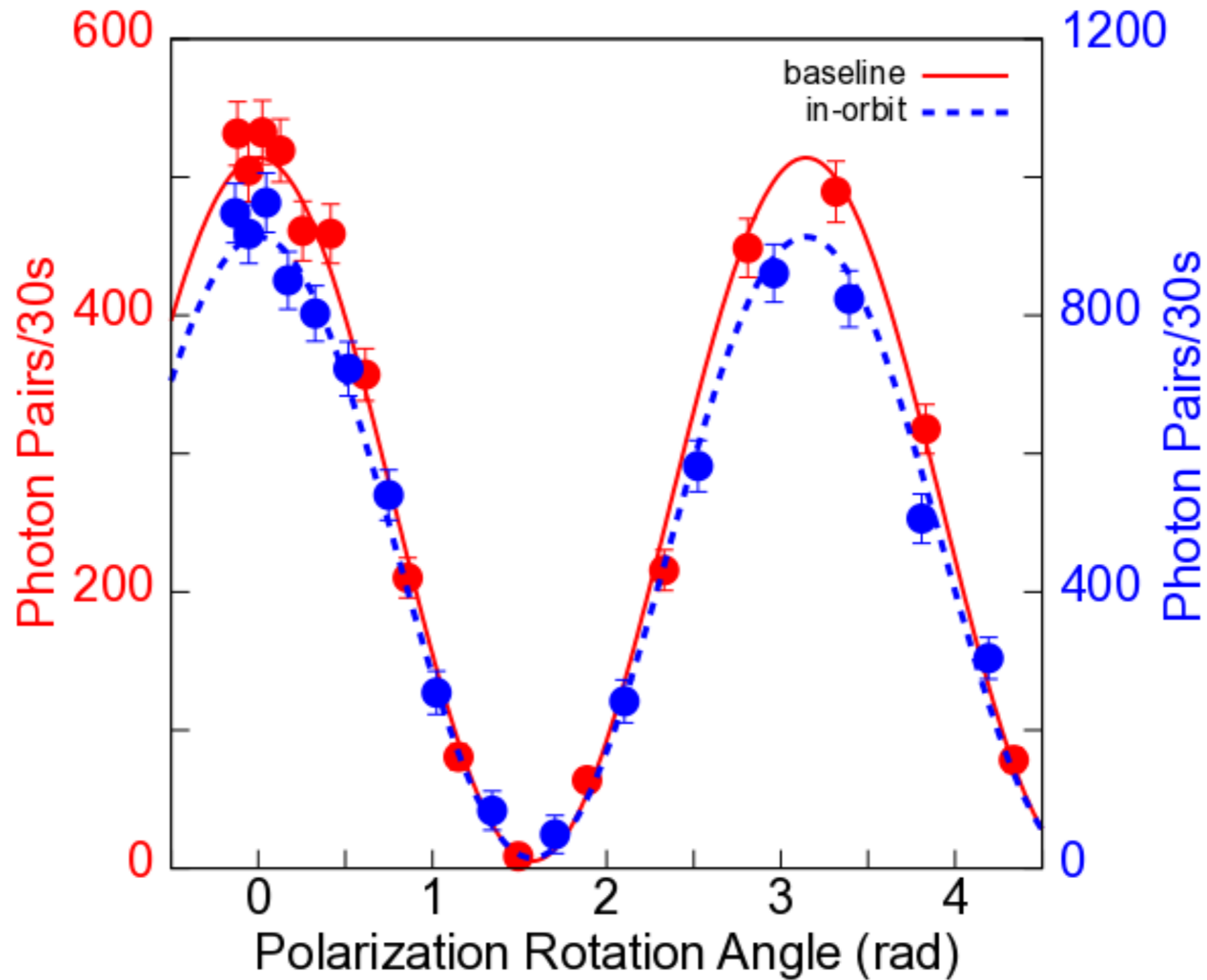

SPEQS road map

	SPEQS-1 CS	<i>SPEQS-1</i>	<i>SPEQS-2</i>
Brightness	3,000	<i>3,000</i>	<i>1,000,000</i>
Visibility	96%	<i>96%</i>	<i>99%</i>
Efficiency	1%	<i>1%</i>	<i>20 %</i>
Power (peak)	2.5W	<i>2.5W</i>	<i>10W</i>
Mass	0.3kg	<i>0.5kg</i>	<i>1kg</i>
Volume	0.25U	<i>0.5U</i>	<i>0.75U</i>

SPEQS road map

	SPEQS-1 CS	<i>SPEQS-1</i>	<i>SPEQS-2</i>
Brightness	3,000	<i>3,000</i>	<i>1,000,000</i>
Visibility	96%	<i>96%</i>	<i>99%</i>
Efficiency	1%	<i>1%</i>	<i>20 %</i>
Power (peak)	2.5W	<i>2.5W</i>	<i>10W</i>
Mass	0.3kg	<i>0.5kg</i>	<i>1kg</i>
Volume	0.25U	<i>0.5U</i>	<i>0.75U</i>

SPEQS road map

	SPEQS-1 CS	<i>SPEQS-1</i>	<i>SPEQS-2</i>
Brightness	3,000	3,000	1,000,000
Visibility	96%	96%	99%
Efficiency	1%	1%	20 %
Power (peak)	2.5W	2.5W	10W
Mass	0.3kg	0.5kg	1kg
Volume	0.25U	0.5U	0.75U

Done

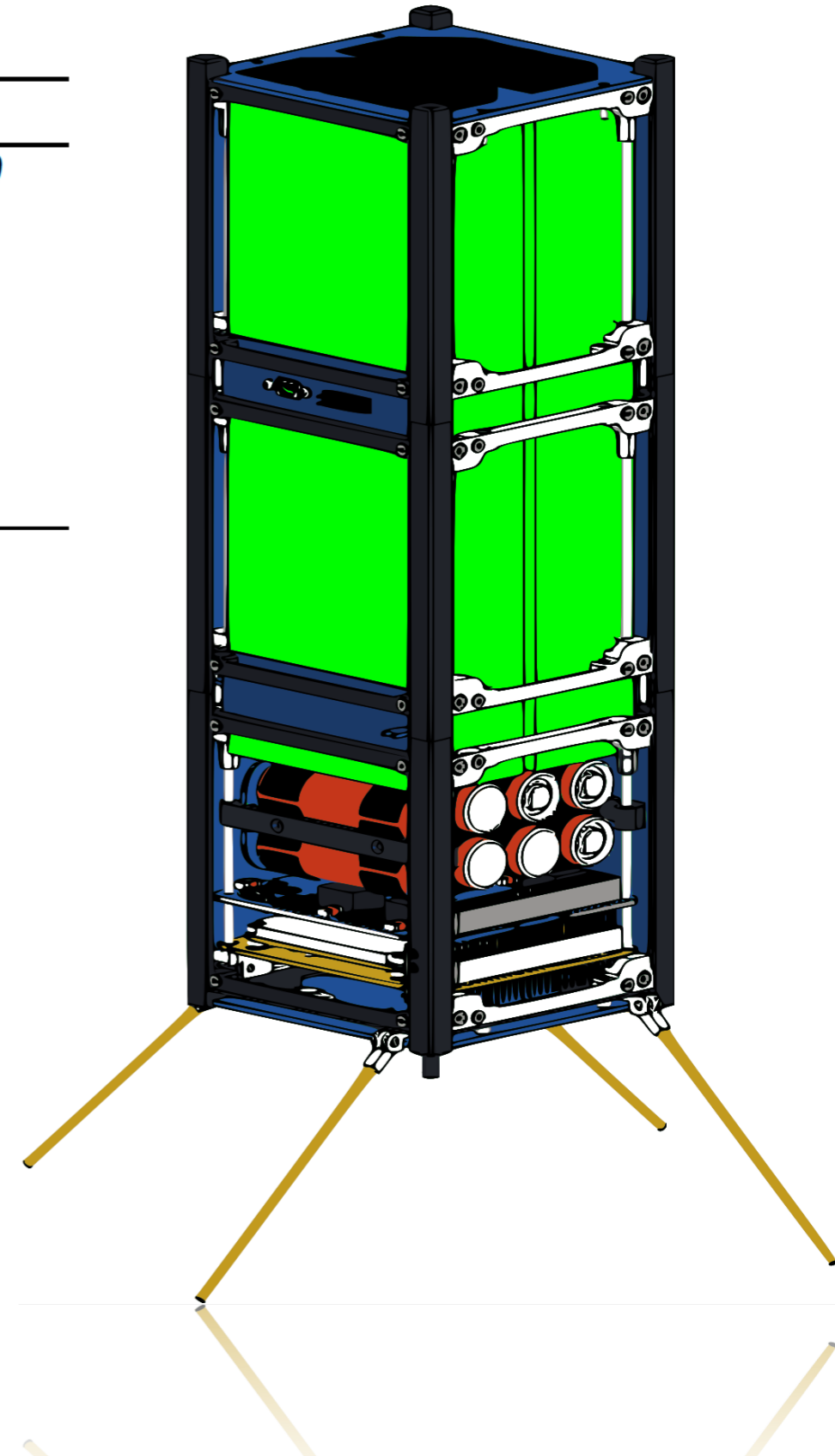

SPEQS road map



	SPEQS-1 CS	<i>SPEQS-1</i>	<i>SPEQS-2</i>
Brightness	3,000	3,000	1,000,000
Visibility	96%	96%	99%
Efficiency	1%	1%	20 %
Power (peak)	2.5W	2.5W	10W
Mass	0.3kg	0.5kg	1kg
Volume	0.25U	0.5U	0.75U

Done

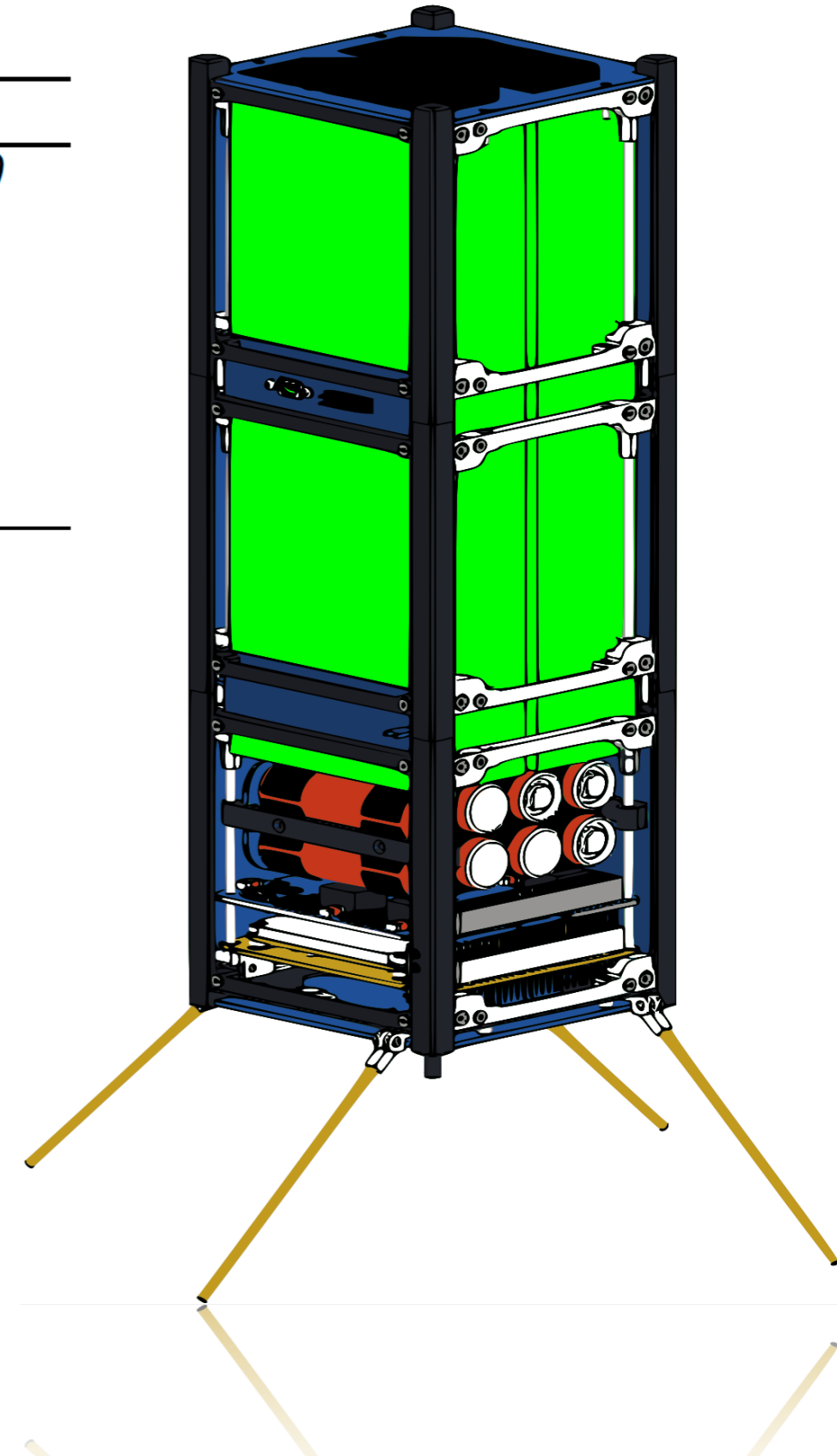

SPEQS road map



	SPEQS-1 CS	SPEQS-1	SPEQS-2
Brightness	3,000	3,000	1,000,000
Visibility	96%	96%	99%
Efficiency	1%	1%	20 %
Power (peak)	2.5W	2.5W	10W
Mass	0.3kg	0.5kg	1kg
Volume	0.25U	0.5U	0.75U

Done

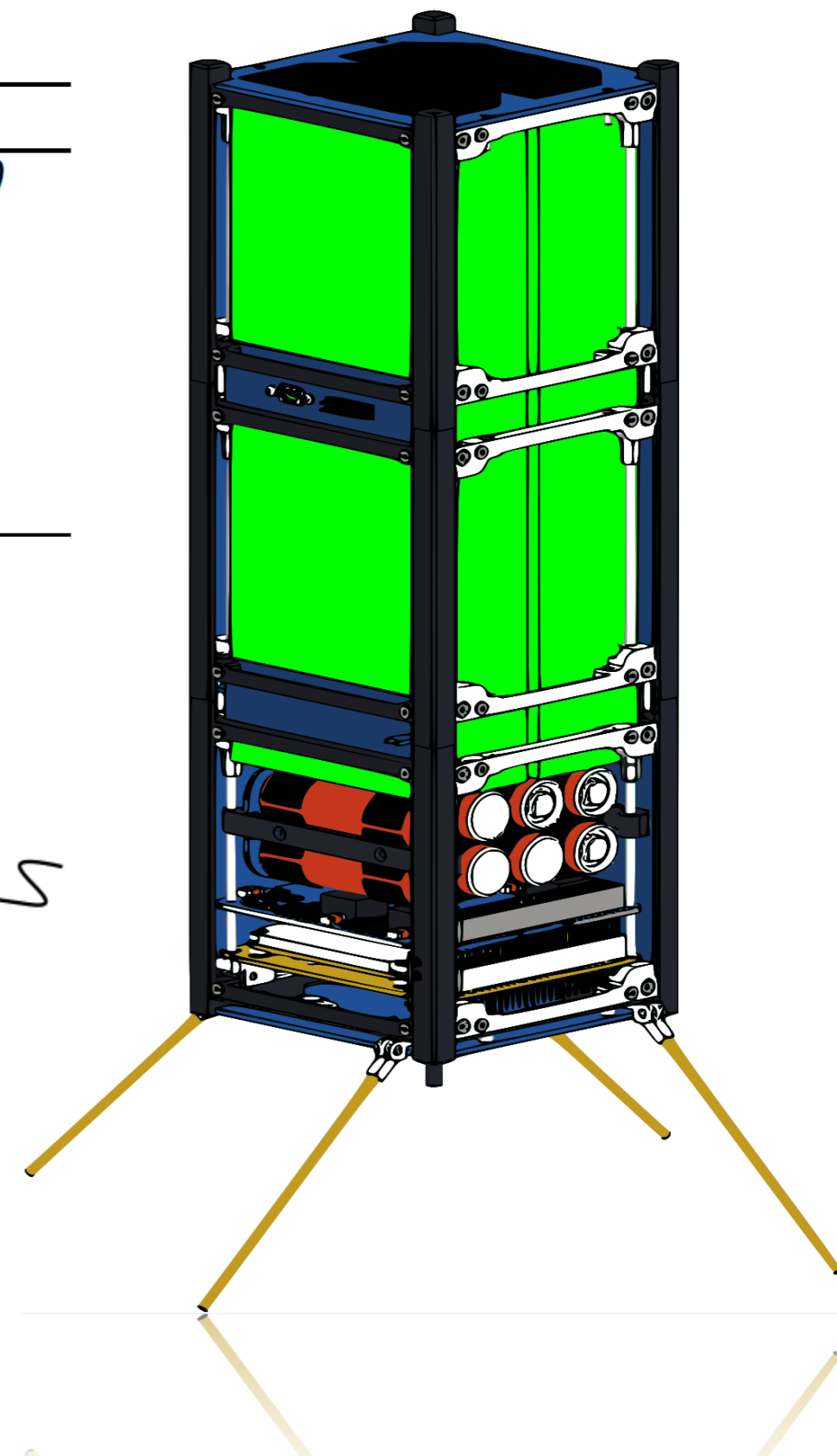
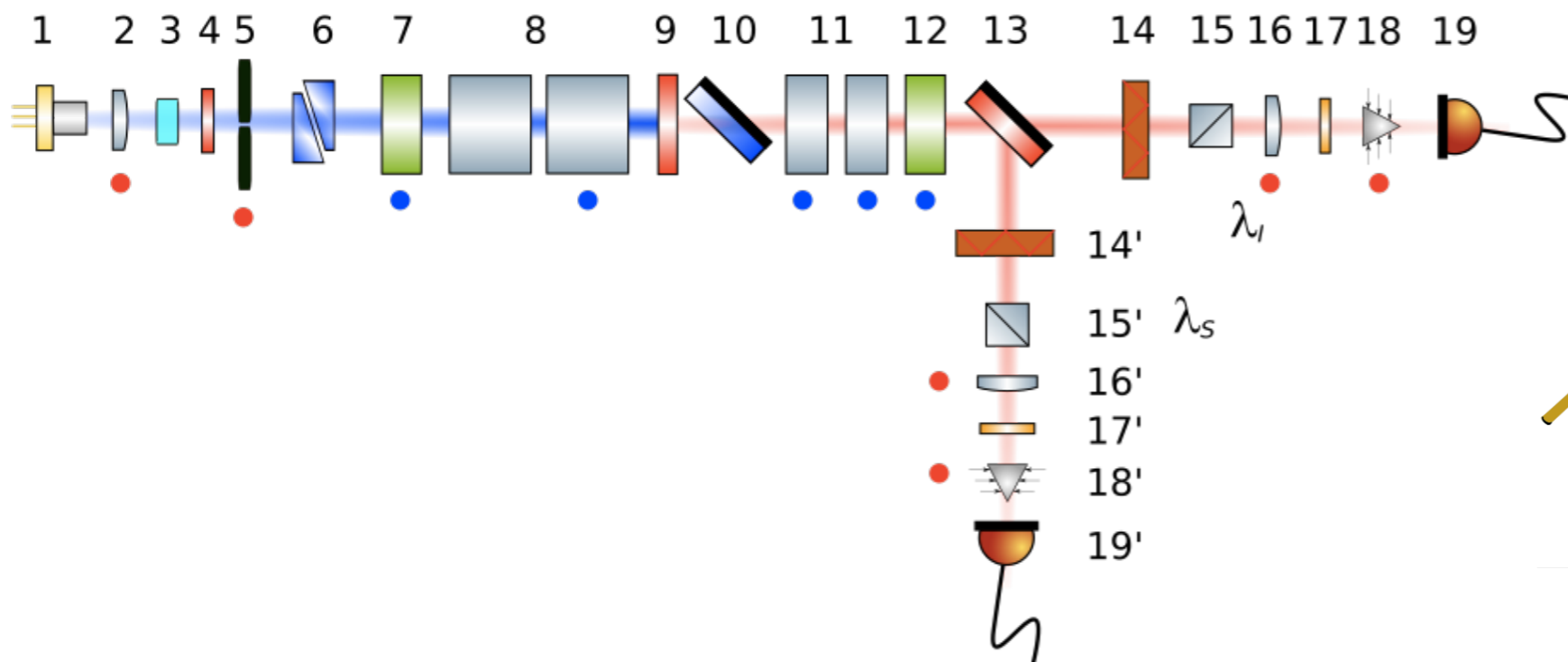

Space based QKD demo

- Optical ground stations
- micro radian ADCS
- Optical beam steering
- High accuracy position knowledge
- satellite to satellite QKD demo partners

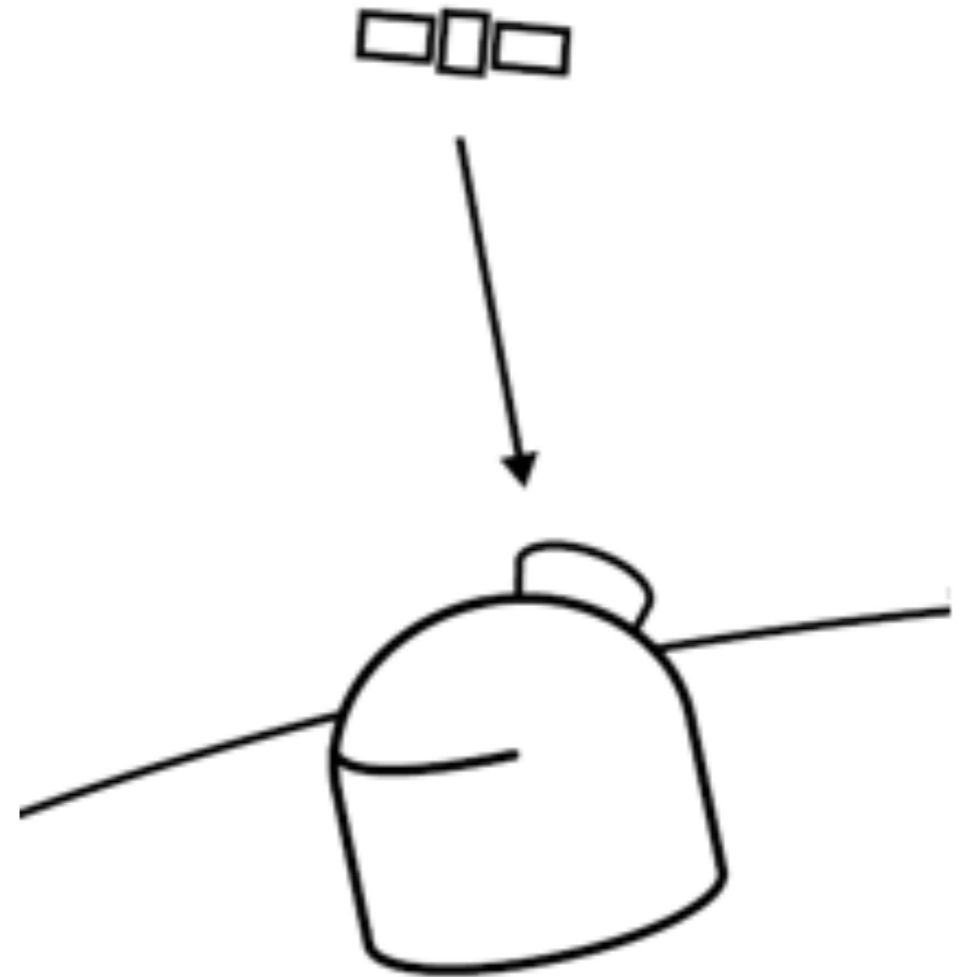

Welcome
Collaborators

**NATIONAL
RESEARCH
FOUNDATION
PRIME MINISTER'S OFFICE
SINGAPORE**



**Ministry of Education
SINGAPORE**

Thank you

<https://sites.google.com/site/phylej/contact-us>

Zhongkan Tang, Yue Chuan Tan, Cliff Cheng and Alexander Ling. Centre for Quantum Technologies, NUS
Luo Sha and Goh Cher Hiang, Department of Electrical and Computer Engineering, NUS
Daniel K.L. Oi, SUPA Department of Physics, University of Strathclyde.