



HaWK Solar Array Technology Advanced Deployable Satellite Power Solution

Date: April 2015

12th Annual CubeSat Developers' Workshop

Presented by: Eric McNaul

MMA Design LLC



Technology Overview



HaWK Series of Solar Arrays (High Watts per Kilogram)

- Portfolio of advanced deployable solar array technologies for next generation space-flight applications
- Modular, scalable, and reconfigurable to meet mission power requirements from CubeSats to 40kW systems
- Innovative stowage and deployment schemes minimize stowed volume, provide positive hold-down restraint, and enable multiple degrees of panel articulation
- Provides a redundant and simplified approach to deployable solar power technology that greatly improves system reliability

Timeline of Technology Maturation

- HaWK technology largely supported by SBIR funding
- MMA Design solar array product portfolio continues to push the state of the art (SOA) in space power performance

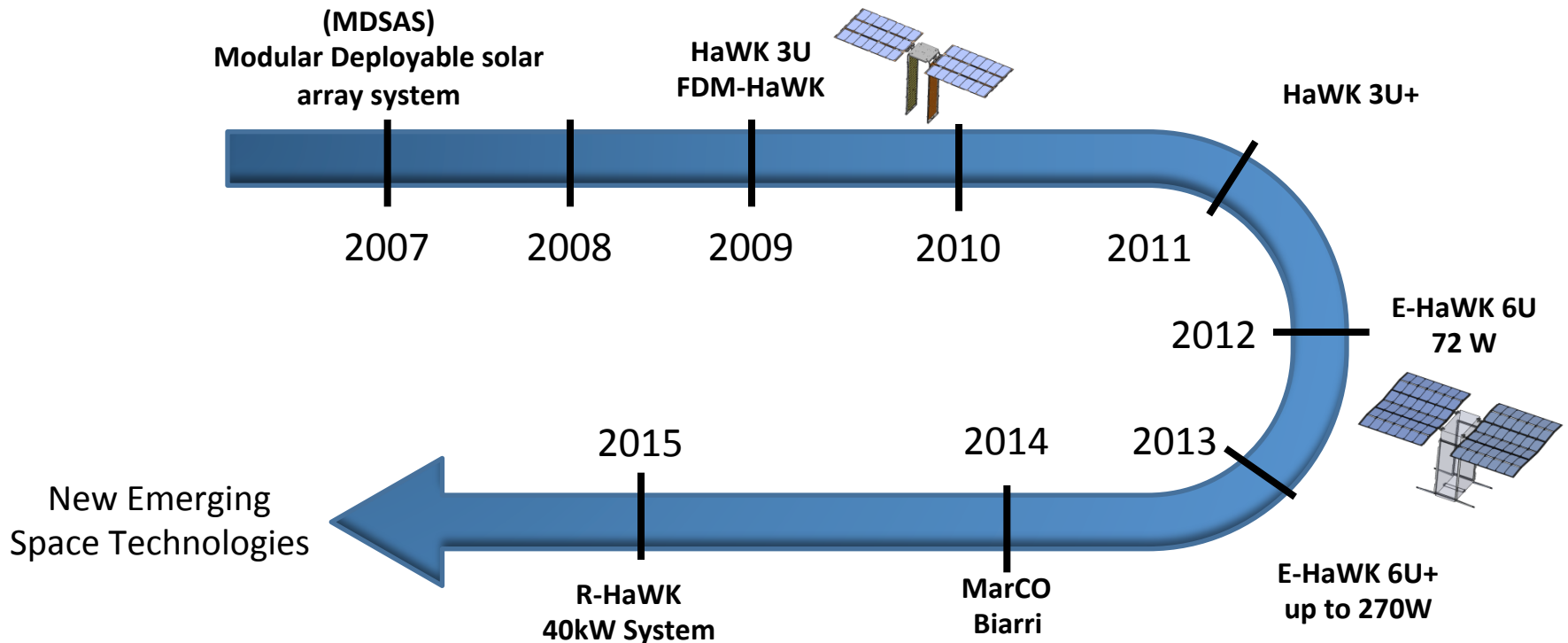

- HaWK solar array architecture provides a building block approach allowing modularity and scalability
- Focus is on maintaining standard components for cost attractive power solutions

36W BOL @ 70°C
Peak Power

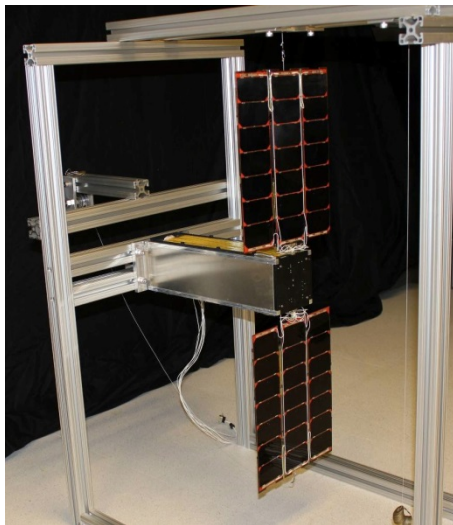

HaWK

72W BOL @ 70°C
Peak Power

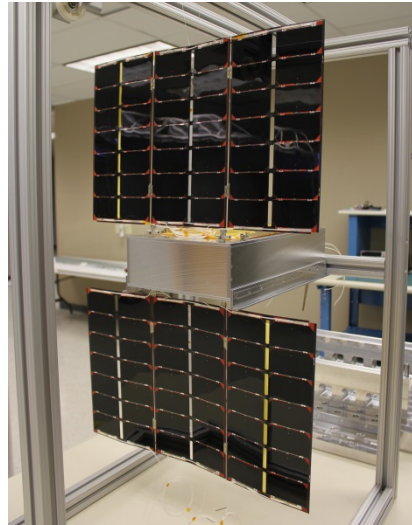

E-HaWK

Advanced proprietary
embodiments at >72W and
targeting >40kW peak power

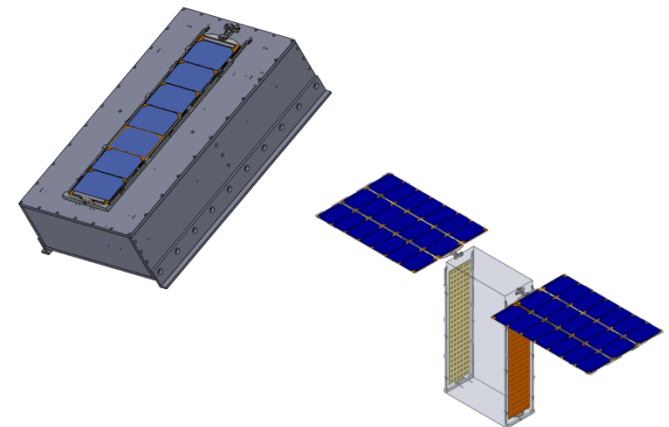

Mission Specific HaWK
Configurations

HaWK modular high performance solar array

- Compatible with 3U and 6U form factors

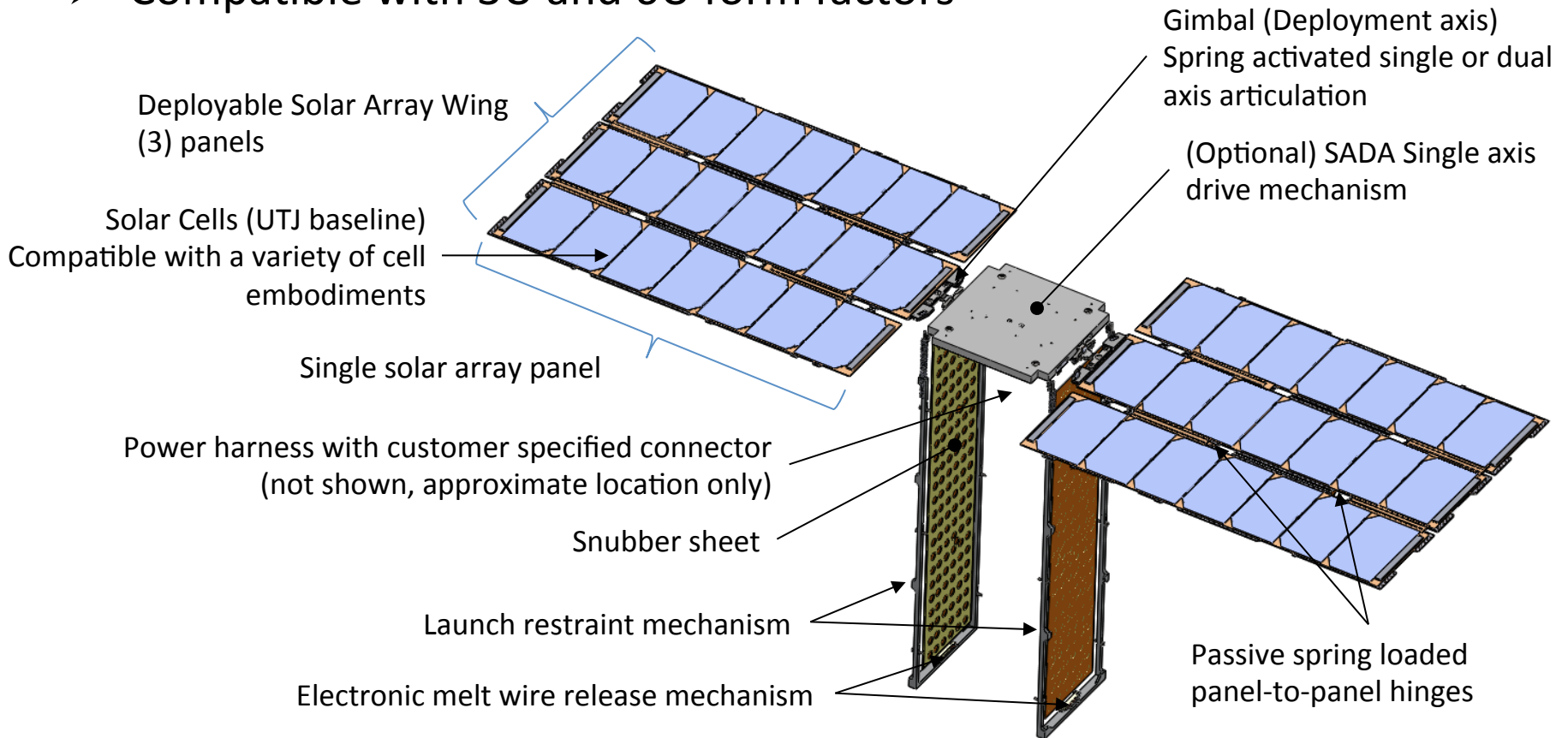

HaWK Specifications

Power Specs

- 36 Watts BOL @70°C Peak Power
- 130 W/kg BOL Specific power
- 99 kW/m³
- Spectrolab UTJ 28.3% at 28°C, AM0
- Discrete integrated by-pass diode

Structural Specs

- 1st mode >1.5 Hz deployed
- Deployment duration (t_0) from launch lock release to full deployment (t_f)
 - <1.0 second
- Solar array system mass – 276.0 grams

Options

- SADA 1U form factor
 - (10cm) 6.5mm thick
- Motion is +/- 180degrees
- Sun tracking

HaWK fit check



1U SADA

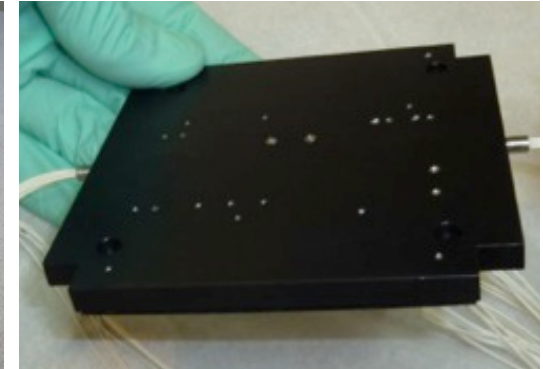

Deployment sequence

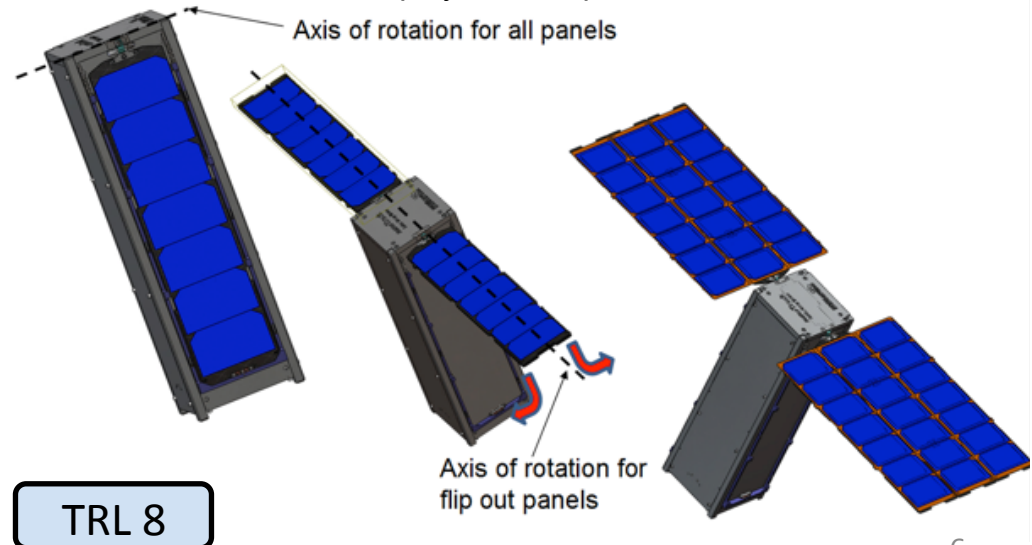

TRL 8

- Fully qualified for the ORS² mission
- HaWK deployable solar arrays will be repurposed for the AFRL Biarri mission

ORS2 HaWK Protoflight Unit

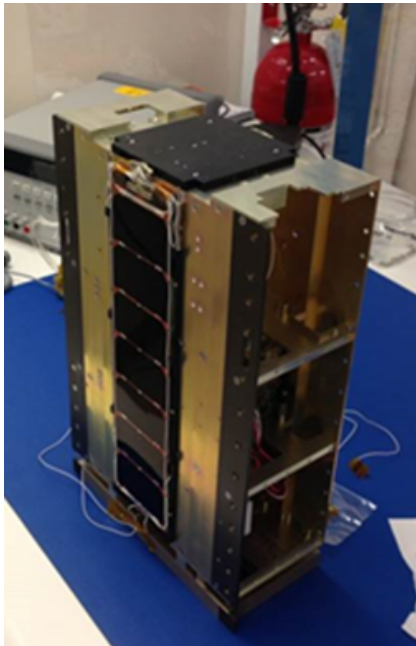

Biarri HaWK Protoflight Unit

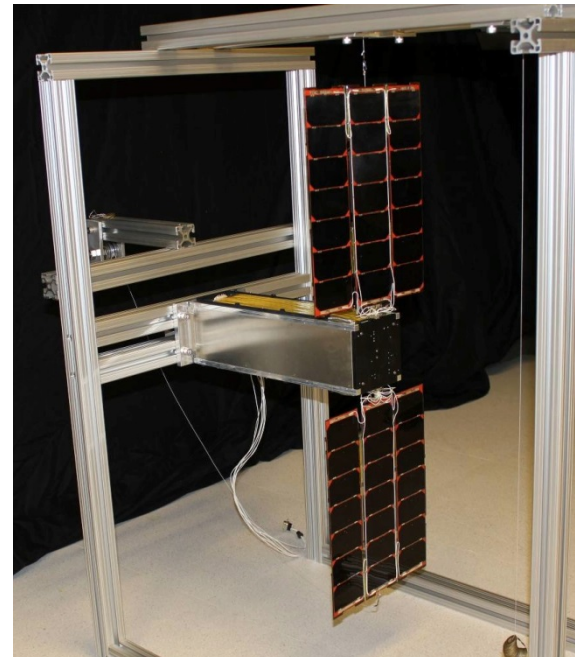

E-HaWK high power solar array

- Multi-panel design for high power missions

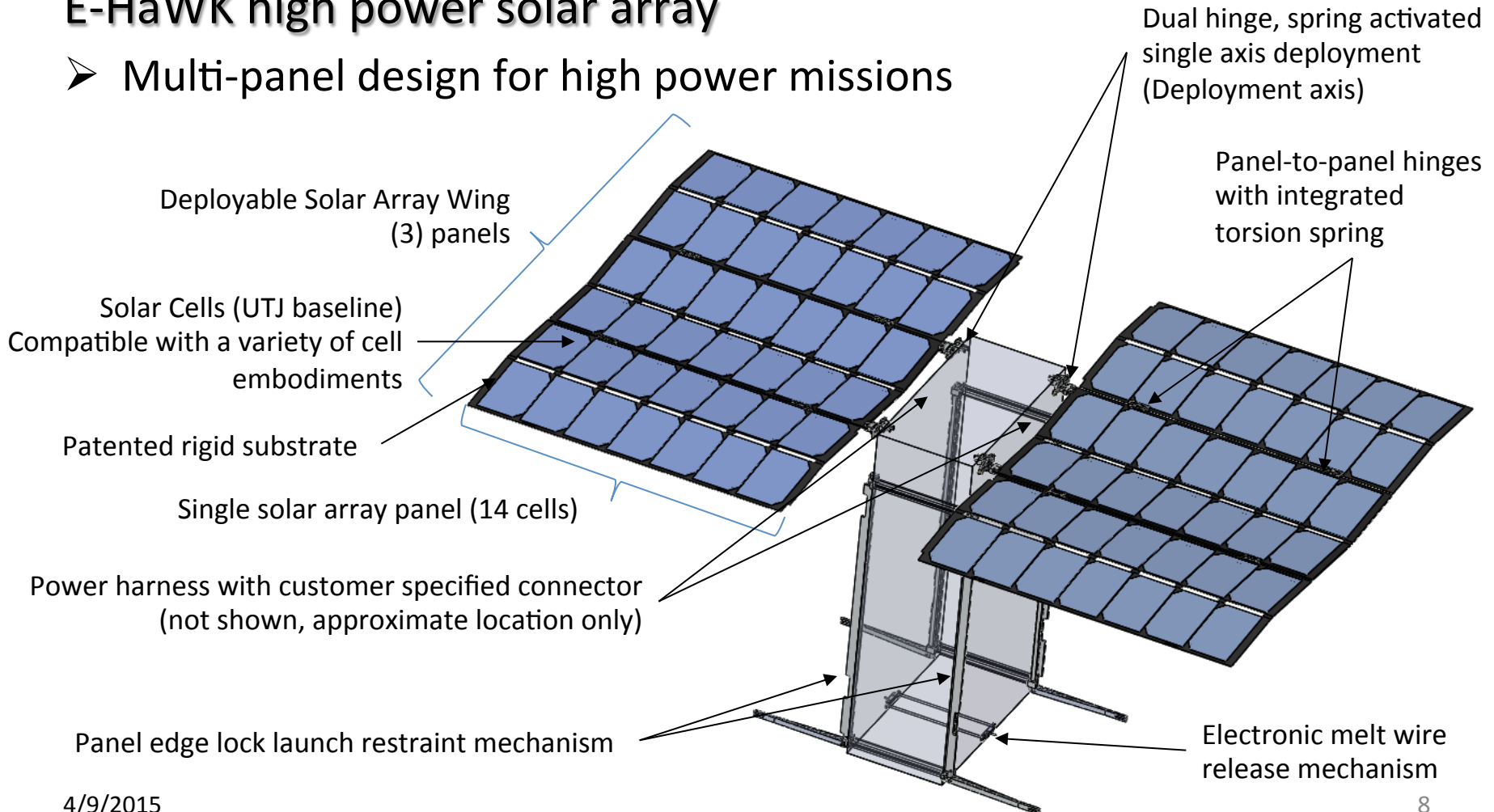

Power Specs

- 72 W BOL @70°C (3) panels per wing config.
- 144 W BOL @70°C (6) panels per wing config.
- 120 W/kg BOL @70°C Specific power
- 80-90 kW/m³
- Spectrolab UTJ 28.3% at 28°C, AM0
- Discrete integrated by-pass diode

Structural Specs

- 1st mode >1.5Hz deployed
- Deployment duration (t_0) from launch lock release to full deployment (t_f)
 - <1.0 second
- Solar array mass –approx. 600 grams
 - Complete system with launch restraint

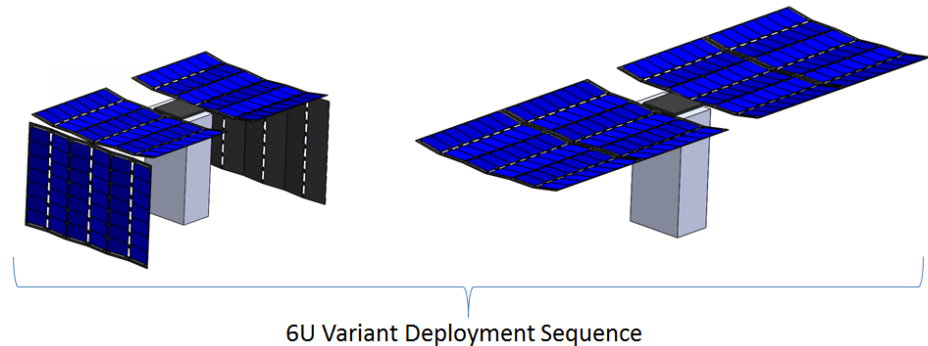
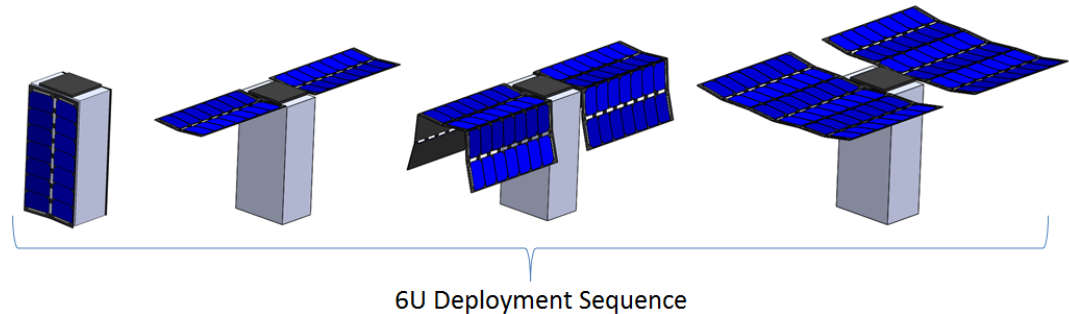

- Risk reduction random vibration testing complete; criteria enveloped industry standards
- Multiple 1G deployment tests completed successfully
- Thermal Cycle testing successfully performed between 80°C and -35°C, 8 cycles with 1 hours dwells

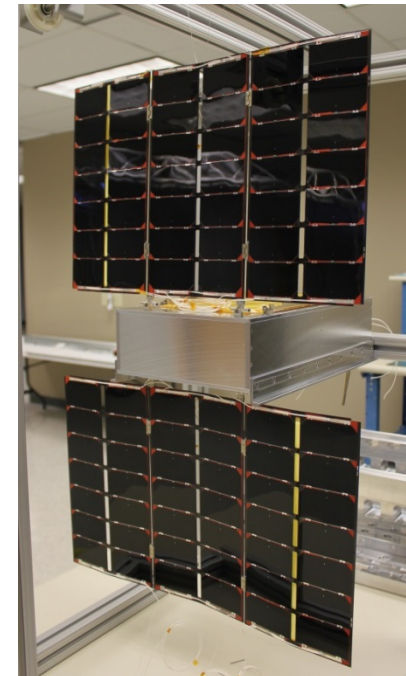
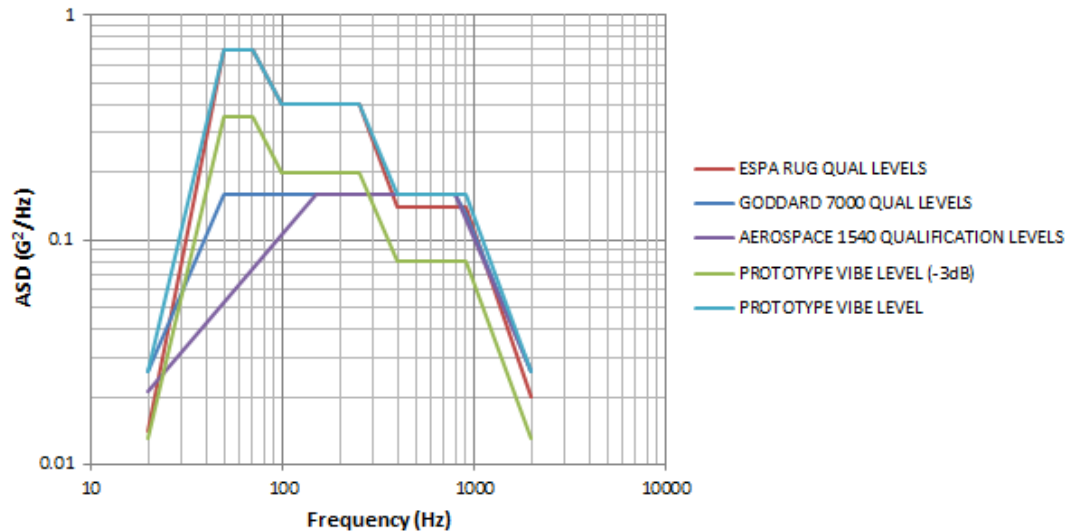

- High technology readiness level
- Flight heritage 2016
- HaWK portfolio of solar array platforms is establishing state of the art technology which will enable current and future high power mission.
- Providing best-in-class power solutions with demonstrated reliability, efficient packaging, modularity, and scalable power
- Offering component commonality and innovative mechanisms aimed at providing elegant solutions at a competitive price point
- Continuous development toward new HaWK configurations to provide power up to 40kW

MMA Design: Flight hardware provider and technology incubator

- Focused on providing technologically advanced high performance space flight hardware for DoD and commercial customers
- 150 combined years of flight hardware design, analysis, fabrication, and test experience

Leslie Seal

Business Development Manager
Phone: (303) 748-6898
Email: lseal@mmadesignllc.com
www.mmadesignllc.com

Eric McNaul

Project Engineering Lead for Deployable
Solar Arrays
Phone: (619) 987-9531
Email: emcnaul@mmadesignllc.com
www.mmadesignllc.com

2555 55th Street, Suite 104
Boulder, Colorado 80301

10,000 sq-ft of AI&T, engineering floor space

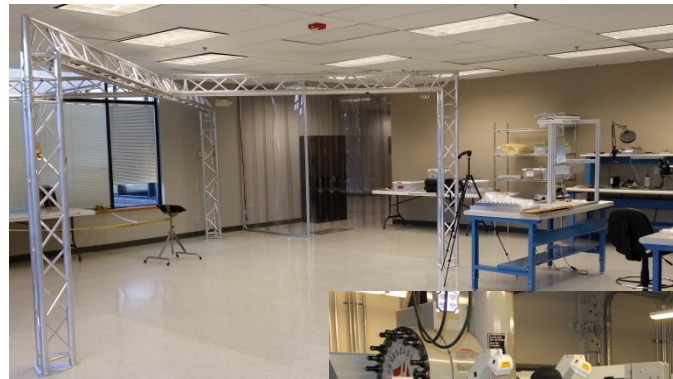

- Class 100,000 clean room
- Machine shop
- Vacuum thermal cycling
- Offload fixtures

