

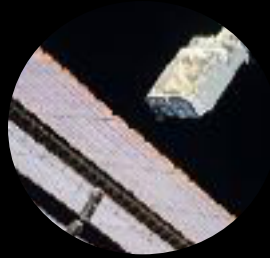

NANORACKS

Maximizing ISS Utilization for Small Satellite Deployments

2015 CubeSat Developers' Workshop
San Luis Obispo, CA



Cubesat Deployment
(From JAXA Airlock)



Kaber NanoSat Deployer



External Platform



Urthecast Earth Observation

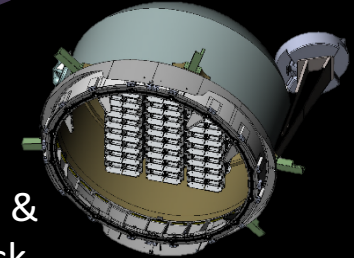

Privately Owned & Operated Airlock



Research Platform

Commercial Researchers, Biopharma

MicroPlate Reader & Biopharm



MixStix

Privately owned microgravity research equipment

NanoLab



Domestic and Foreign Industry

Commercial and Government Organizations Worldwide

Own Platforms

Space Station Operating System: Free Flyers, Commercial Modules, Commercial Space Station



Evolution of NanoRacks ISS Hardware & Customer Base

2009 2010 2011 2012 2013 2014 2015 2016 2017 2018 ²

Sampling of our Customers

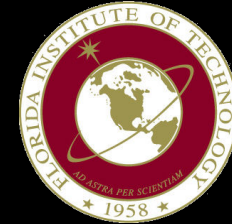
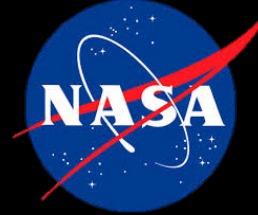

NanoRacks CubeSat Deployer (NRCSD)



- 51.6 degree inclination, 385-415 KM
- Orbit lifetime 6-12 months
- Deployment typically 1-3 months after berthing
- Soft stowage internal ride several times per year



NRCSD

- Each NRCSD can deploy up to 6U of CubeSats
- 8 NRCSD's per airlock cycle, for a total of 48U deployment capability
- ~2 Air Lock cycles per mission

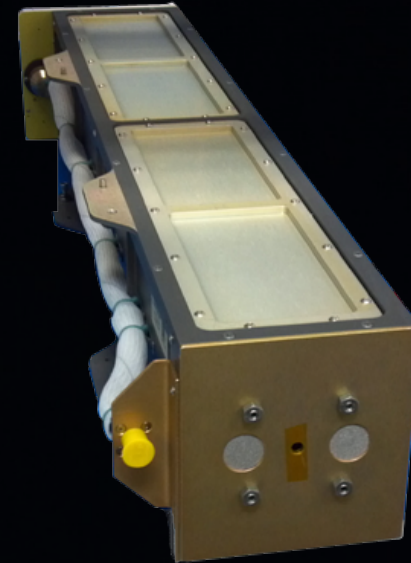



2. Launched by ISS visiting vehicle

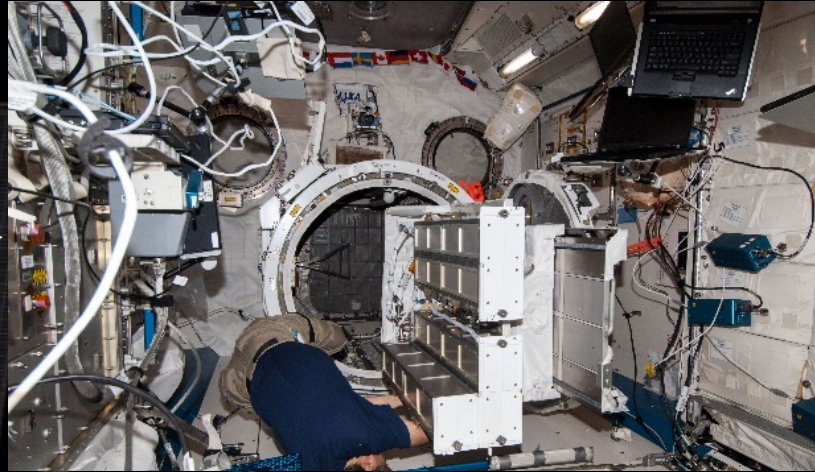

3. NRCSDs installed by ISS Crew

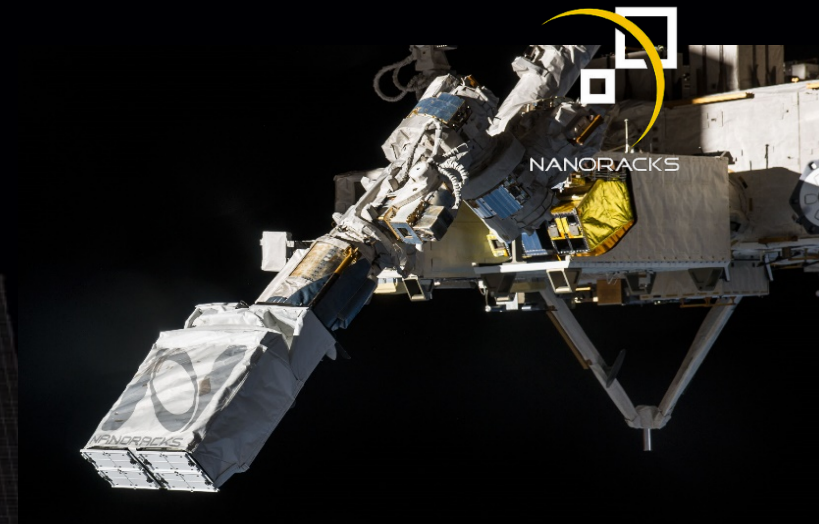

6. NRCSDs positioned by JRMS



1. NRCSDs transported in CTBs



4. JEM Air Lock depress & slide table extension

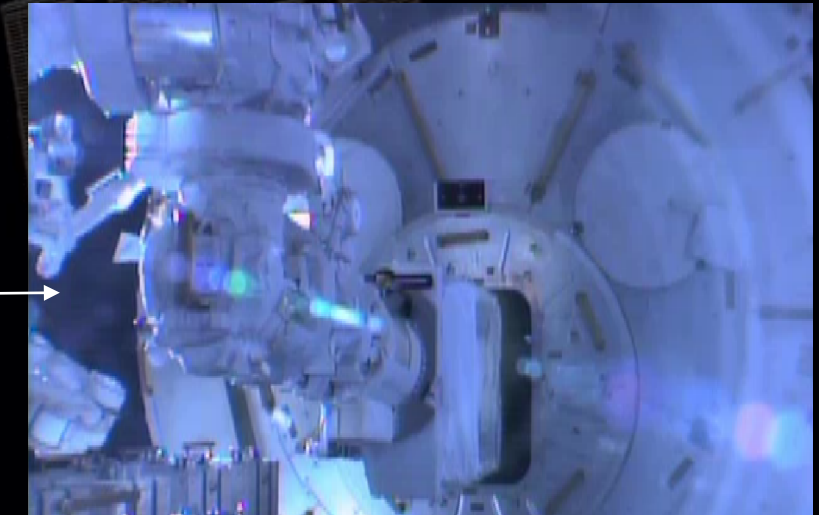

5. Grapple by JRMS



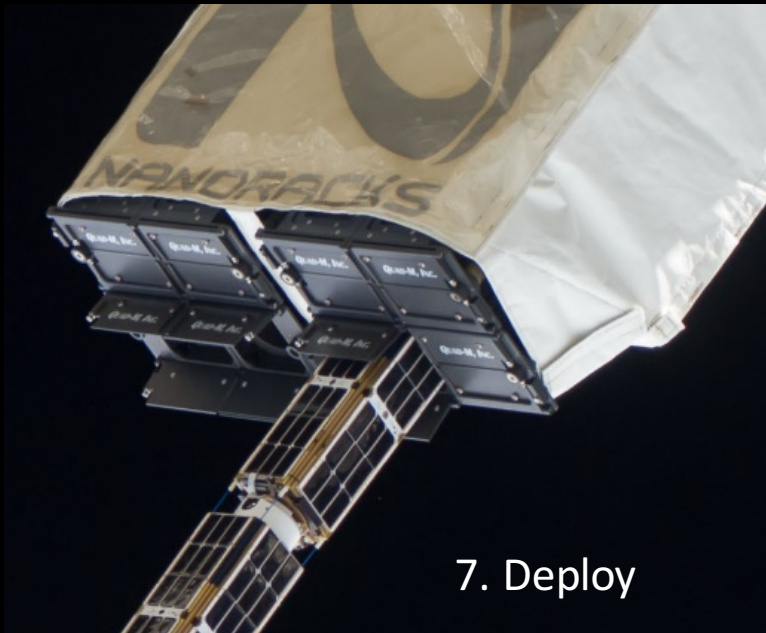

7. Deploy

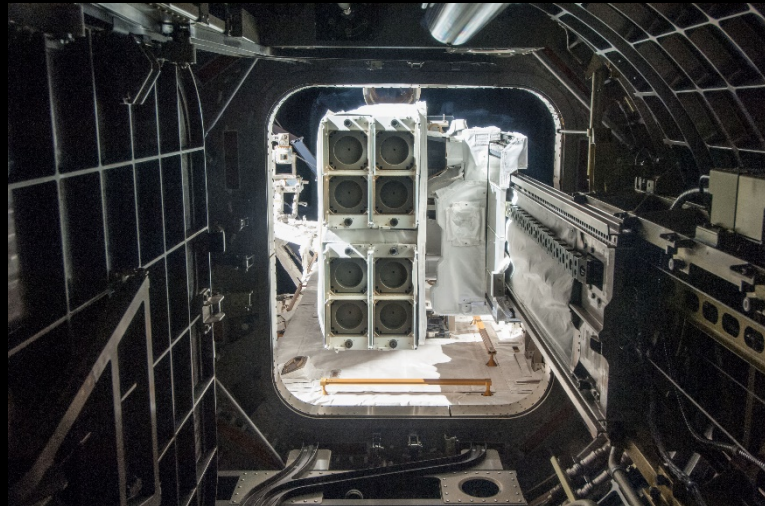
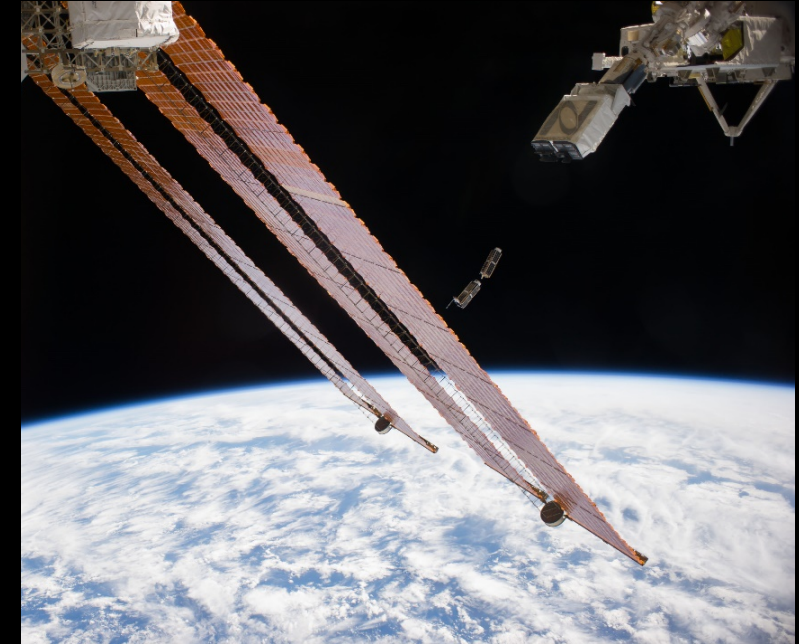
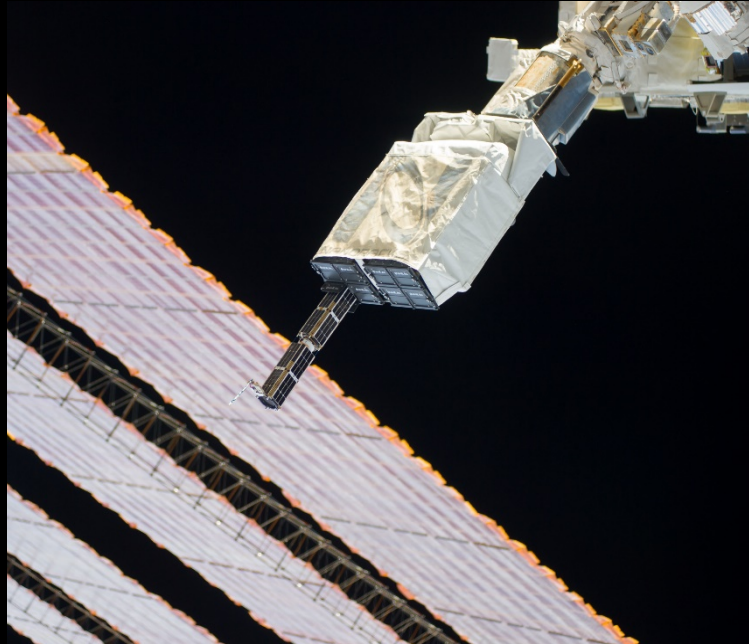

8. JRMS return NRCSD-MPEP stack to slide table; Slide table retracts and pressurizes JEM air lock



9. ISS Crew un-install first 8 NRCSDs; repeat install/deploy for second set of NRCSDs

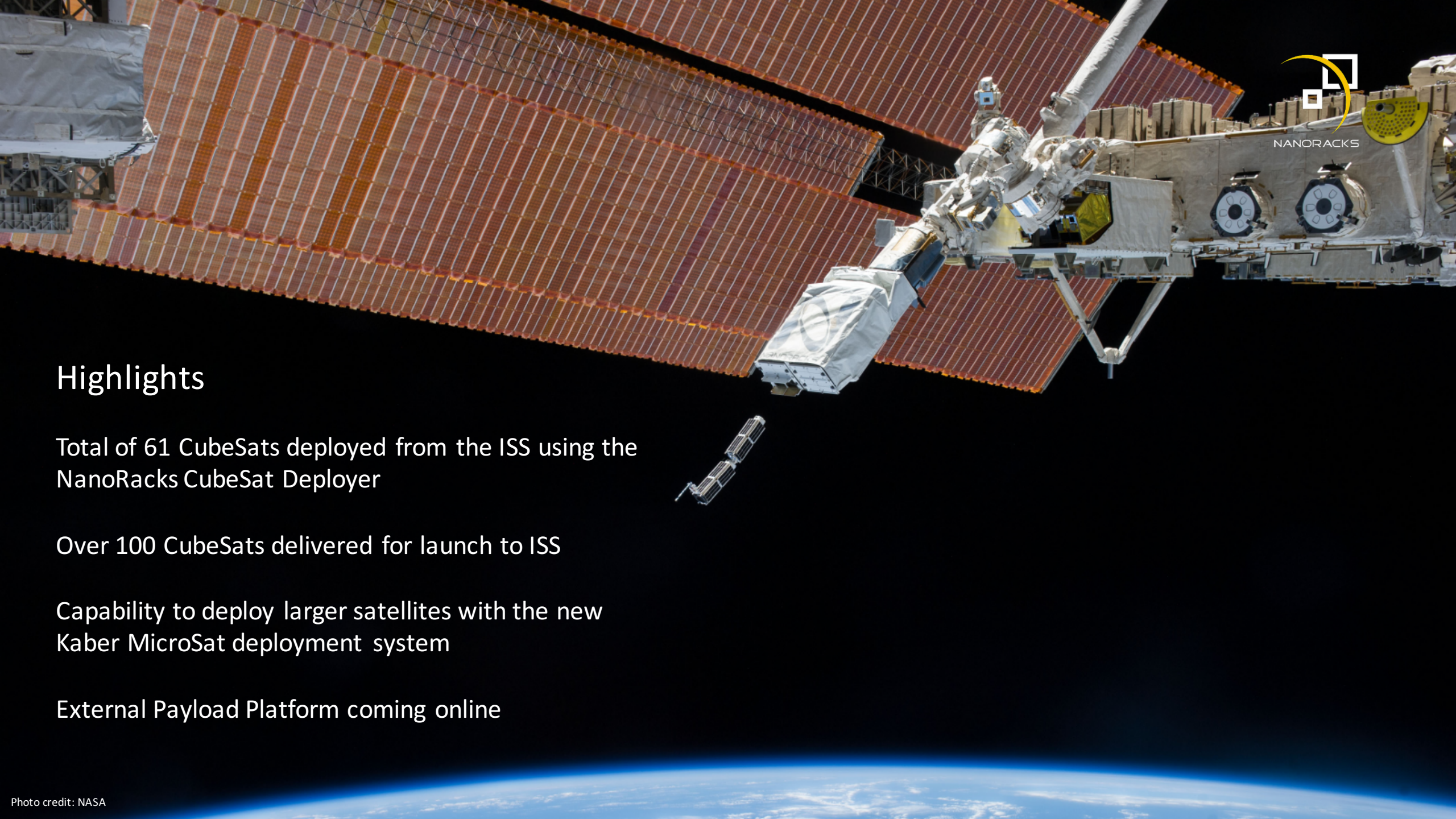

Highlights

Total of 61 CubeSats deployed from the ISS using the NanoRacks CubeSat Deployer

Over 100 CubeSats delivered for launch to ISS

Capability to deploy larger satellites with the new Kaber MicroSat deployment system

External Payload Platform coming online



- NanoRacks CubeSat Mission 1
- Orb-1, Launch Jan 9, 2014
- Air Lock Cycle 1, Feb 11-15, 2014
- Deployers 1-8 (all Planet Labs Doves)

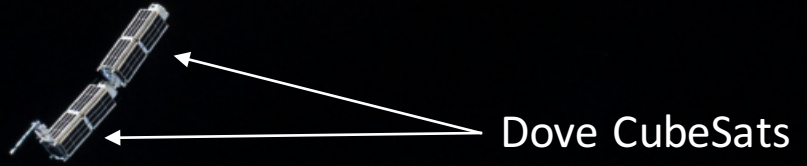



- NanoRacks CubeSat Mission 1
- Air Lock Cycle 2, Feb 25-28, 2014
- Deployer 15

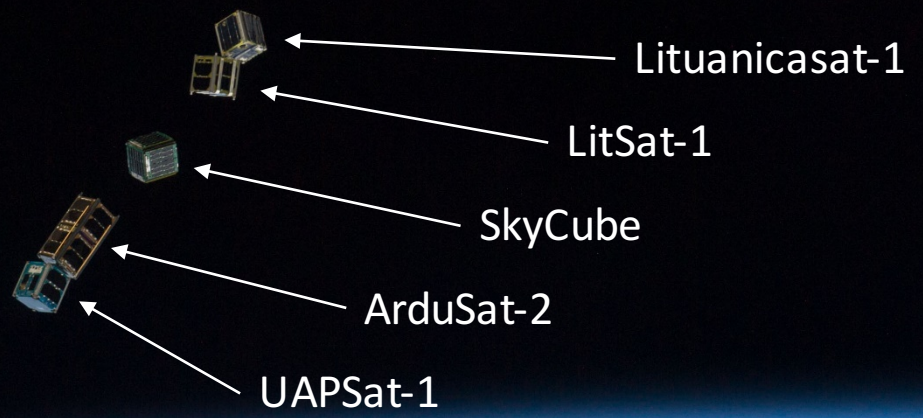

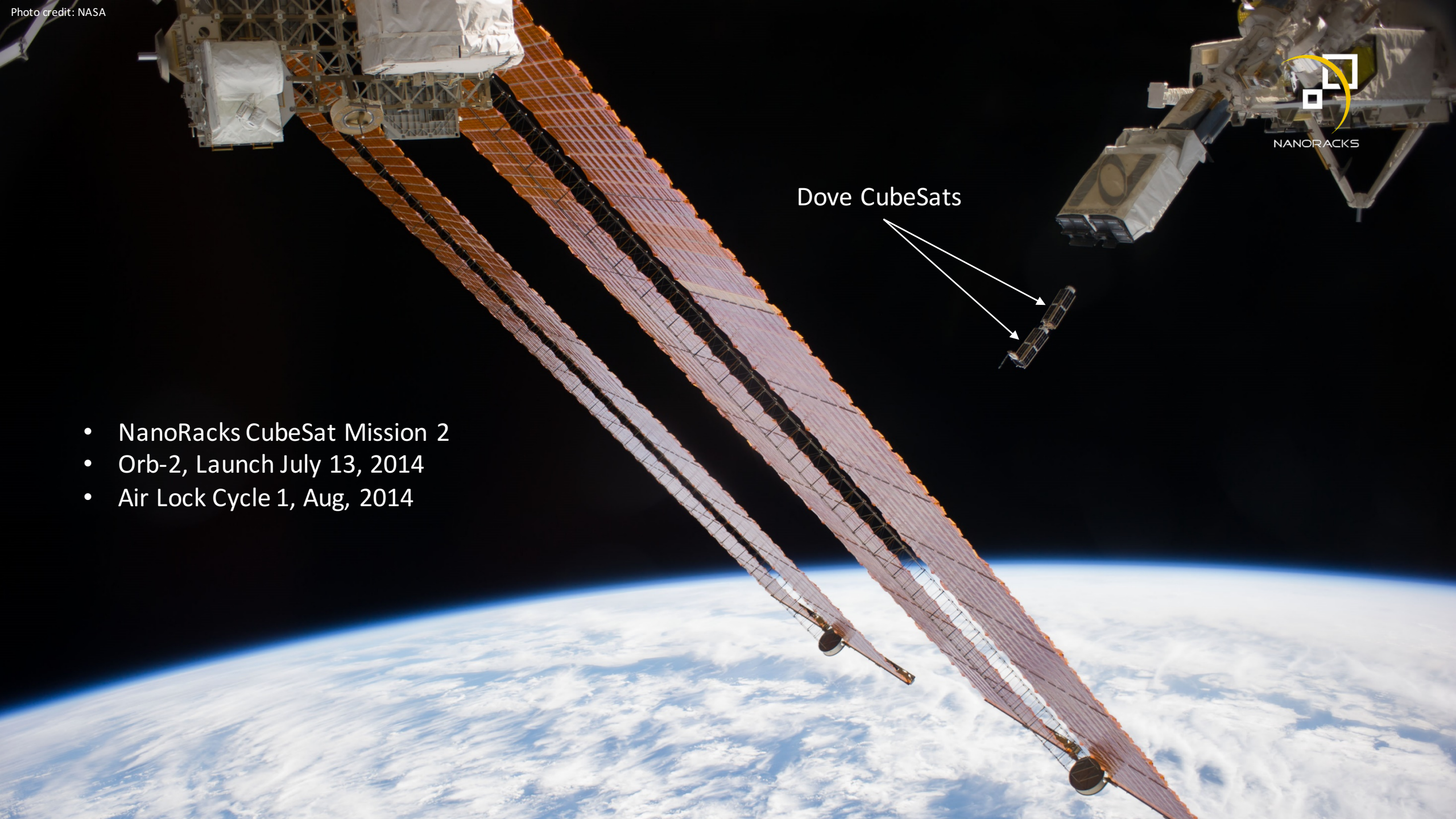

Dove CubeSats

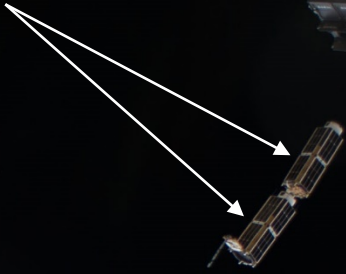

- NanoRacks CubeSat Mission 2
- Orb-2, Launch July 13, 2014
- Air Lock Cycle 1, Aug, 2014

NanoRacks Deployer Anomaly

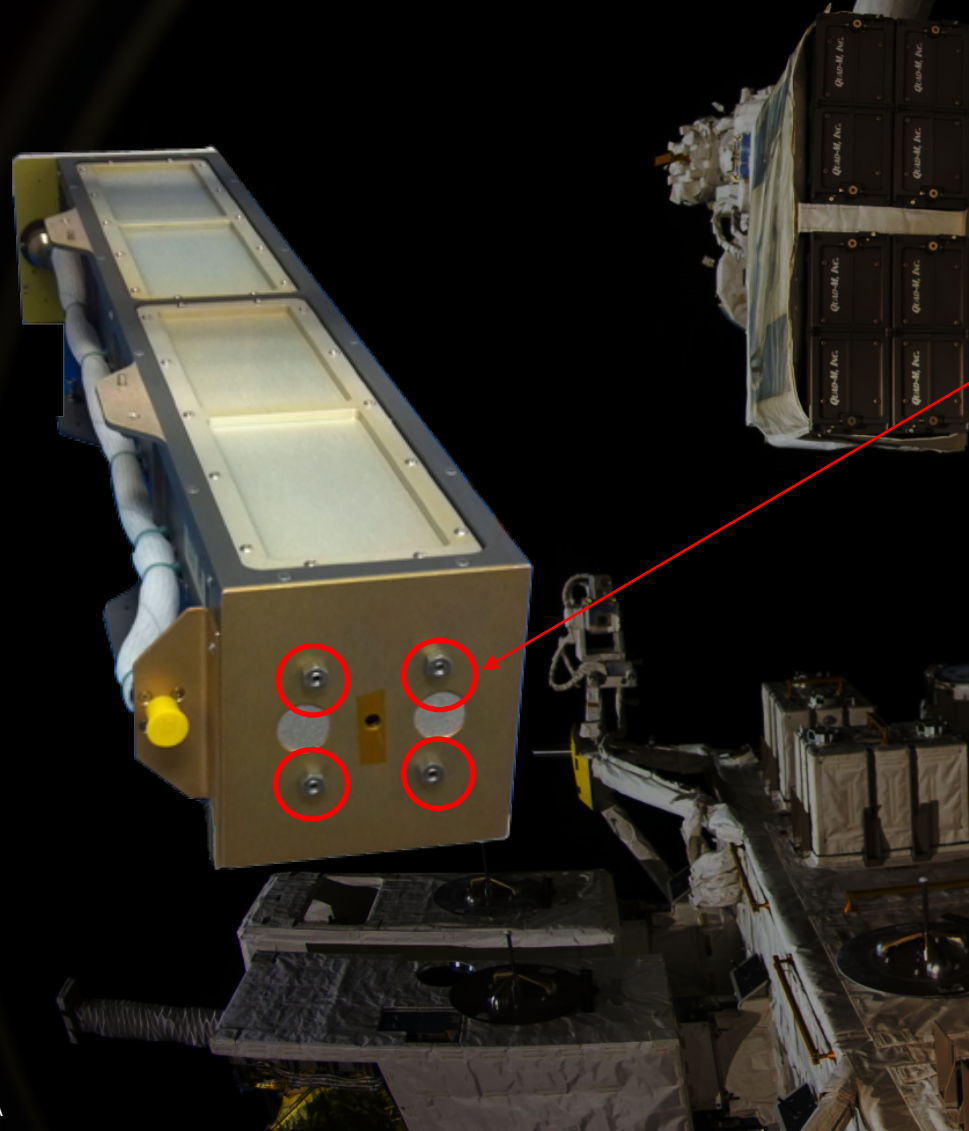

- On-orbit deployment issues observed
- NRCSDs returned safely to JEM
- Problem identified and replicated on the ground
- Coordinated path forward with NASA and JAXA, with oversight from AeroSpace Corp
- Deployments resumed February 2015
- On Orbit Repair –All satellites deployed!



Photo credit: NASA

On-Orbit Repairs
Implemented

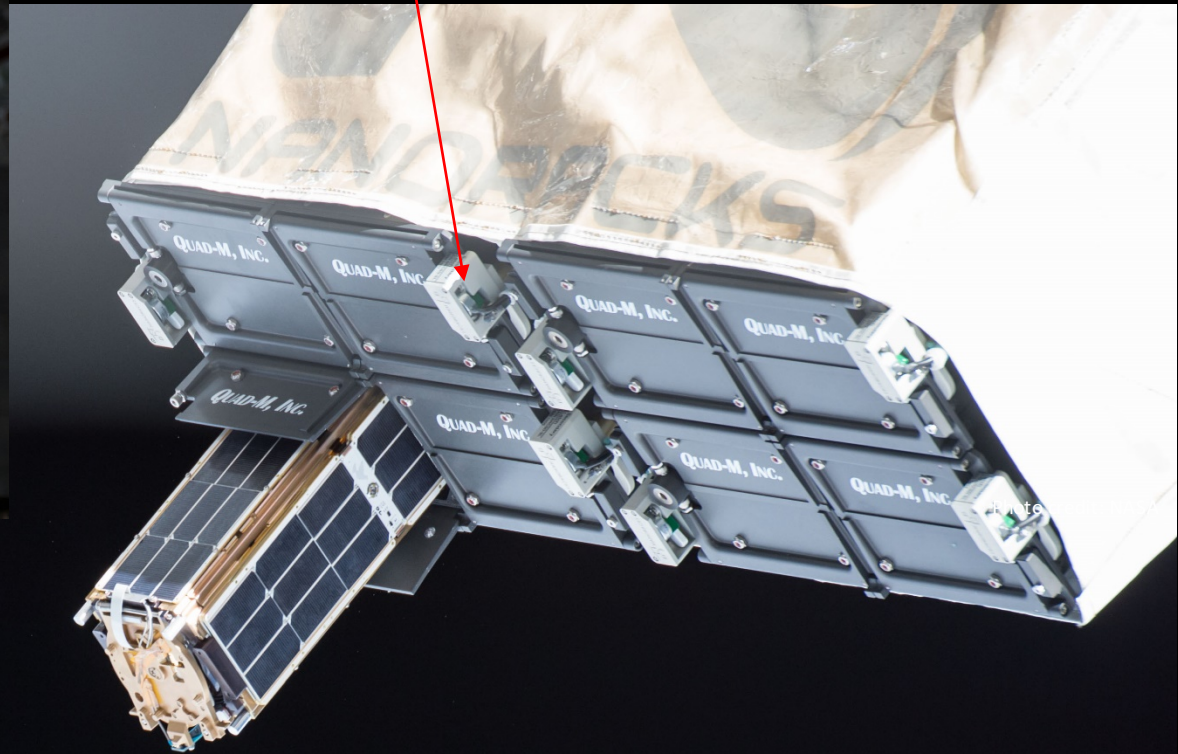

Photo credit: NASA

*“Judgment is that NanoRacks has been diligent in assessing NRCSD failures and identifying design problems”
– AeroSpace Corporation*

- NanoRacks CubeSat Mission 2
- Air Lock Cycle 2, Feb/Mar 2015

MicroMAS

Lambdasat

NanoRacks CubeSat Mission 3



- Majority of CubeSats lost due to launch failure on Oct 28, 2014
- Several deployers/CubeSats recovered!
- Reflight achieved

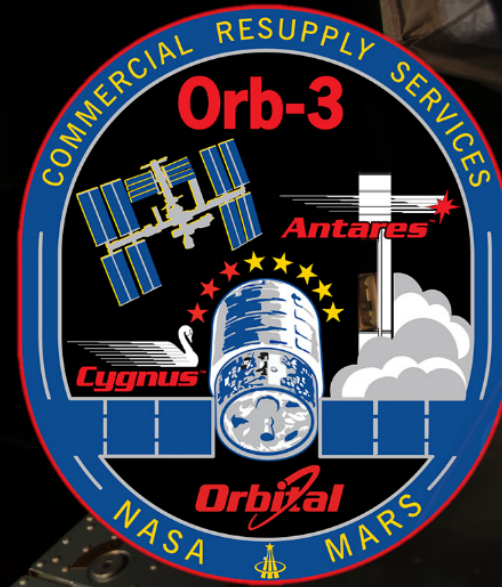

NanoRacks CubeSat Mission 3'



- SpaceX CRS-5
- Planet Labs Flock 1D' – 2 Doves



Photo credit: NASA

Astronaut Terry Virts swaps in Flock1D' Doves

NanoRacks CubeSat Mission 4

- SpaceX CRS-6
- Planet Labs Flock1E – 14 Doves
- Booz Allen Hamilton, Centennial-1
- Planetary Resources Inc., Arkyd-3



Upcoming CubeSats in 2015

- More Doves!
- St. Thomas More Cathedral School, STMSat-1
- GomSpace, GOMX-3
- Aalborg University, AAUSat-5
- University of Colorado Boulder, MinXSS
- NASA Ames Research Center, NODeS
- Valley Christian Schools, Quest-1
- and more!



Kaber Small Satellite Deployer System

- Kaber Deployer
- JCAP
 - JEM slide table interface
- Satellite Separation System
 - Motorized Lightband (MLB)
 - NanoRacks Separation System (NRSS)

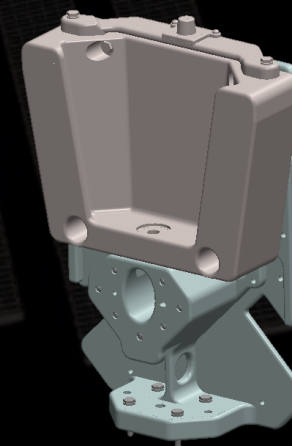
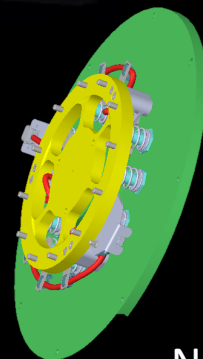
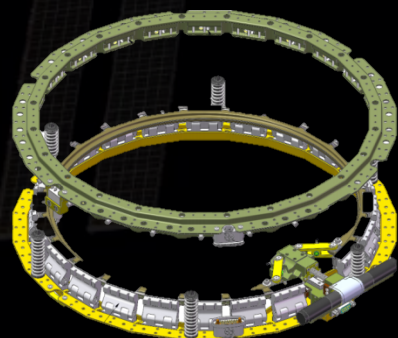
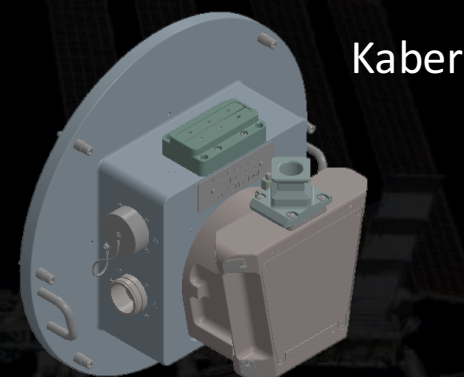

NanoRacks Kaber Deployment Service- JEM Air Lock Payload Envelope

Payload Envelope $\sim 1\text{m} \times 0.5\text{m} \times 0.5\text{m}$

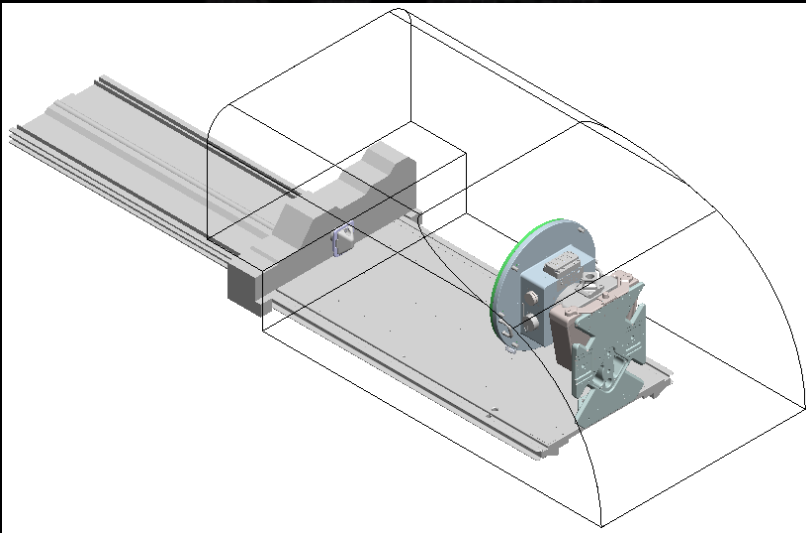

Payload Mass: up to 100Kg

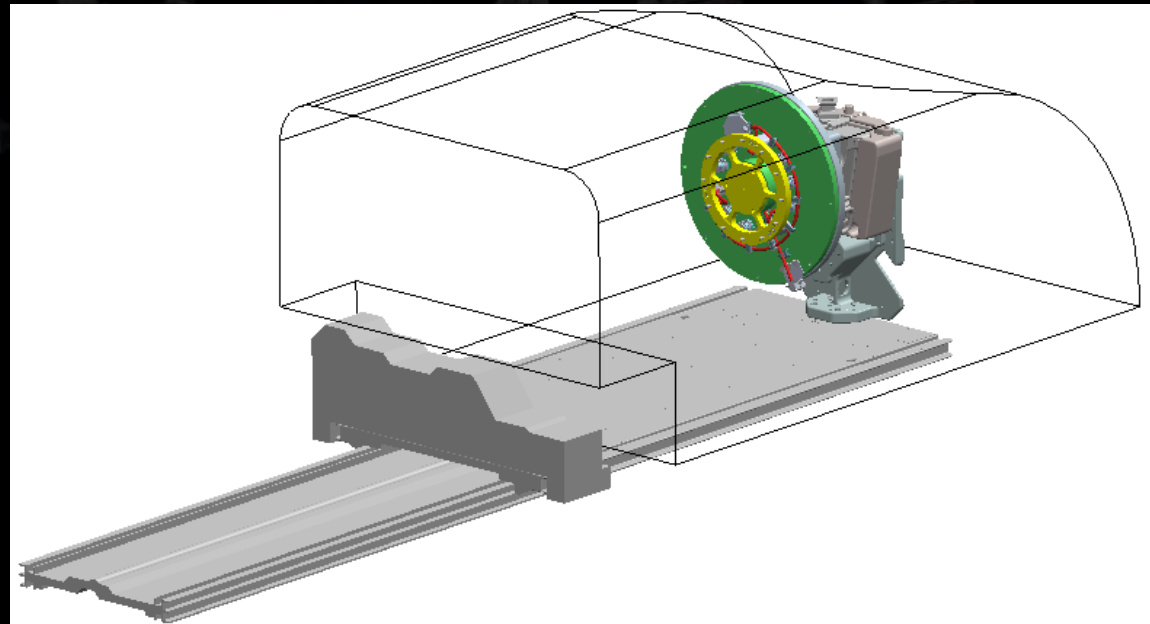

NanoRacks External Platform

External Platform

- Up to 9 4U CubeSat size payloads outside the ISS
- Standard mission duration 15 weeks
- Excellent viewing conditions for Earth observation
- Full end-to-end mission service

NanoRacks External Platform

Standard payload provisions	
Voltage	28 Vdc \pm 2 V or 120 Vdc as option
Total power	30 W at 28 Vdc
Maximum current	2 A
USB 2.0 bus	5 Vdc / 500 mA, non-switchable
Total payload data rate	up to 8 Mbit/s

- EP provides all functions of the conventional spacecraft bus
- Ideal platform for small size hosted payloads
- No further subsystems necessary
- Improved anomaly resolution by human in the loop

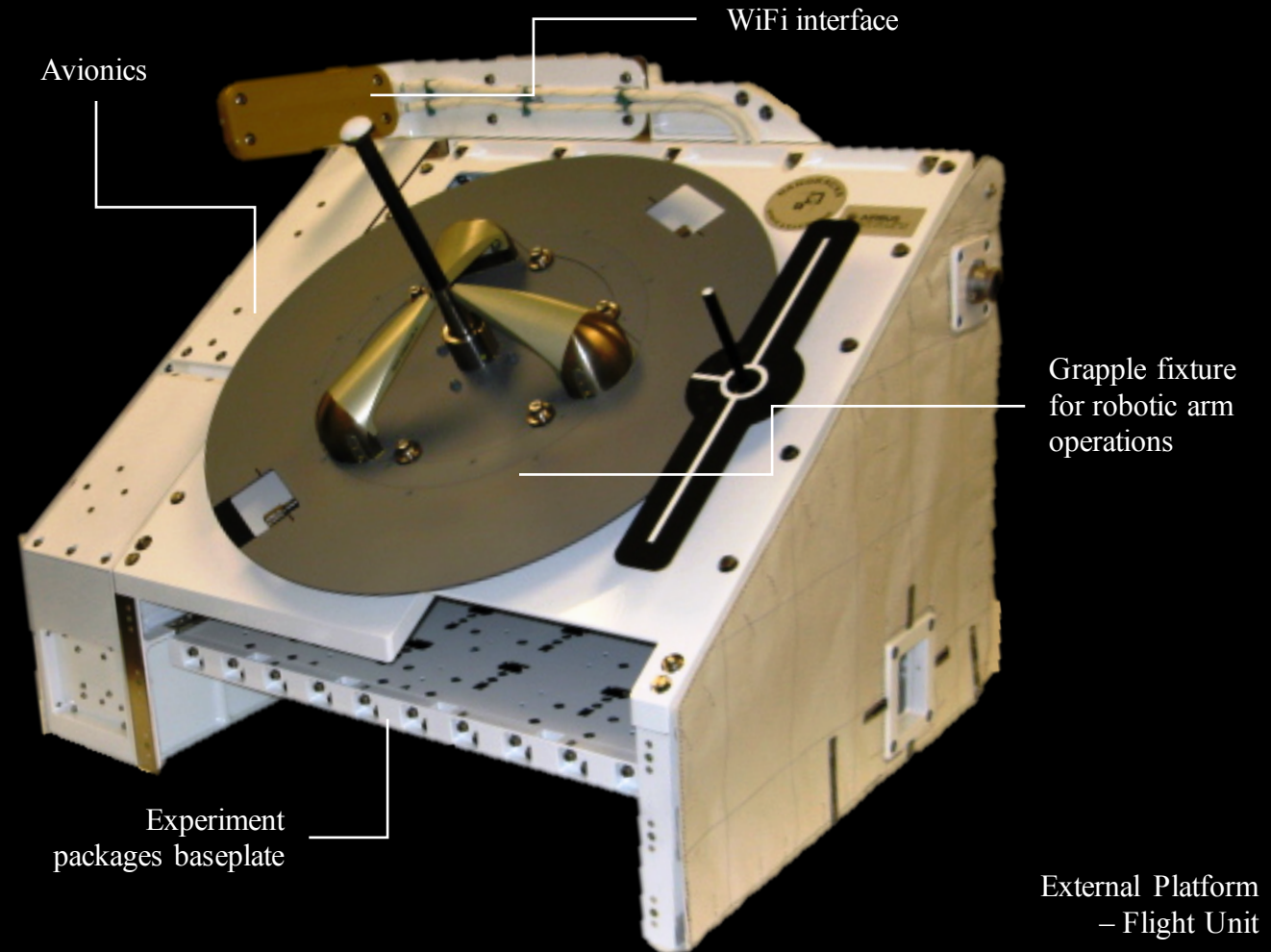

Future Capabilities

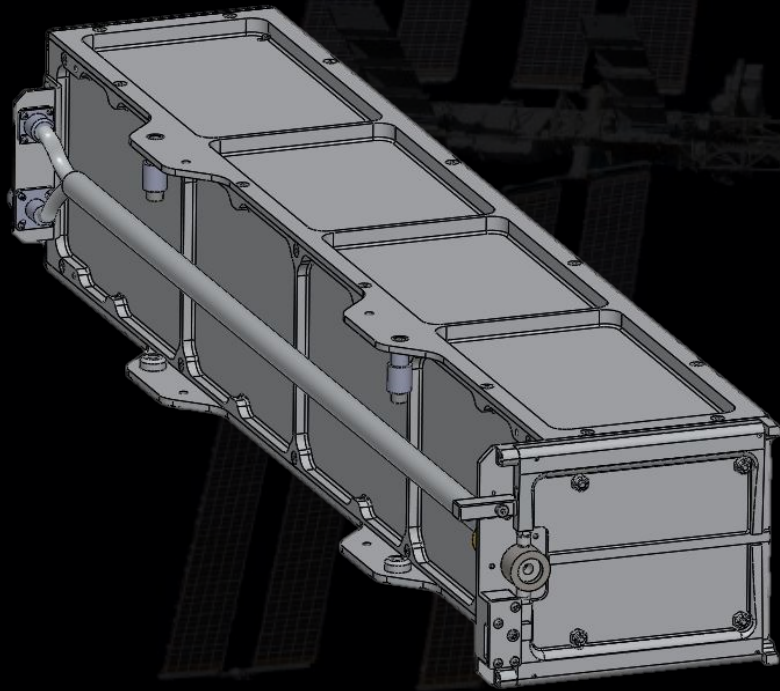

Traditional 6U NRCSD

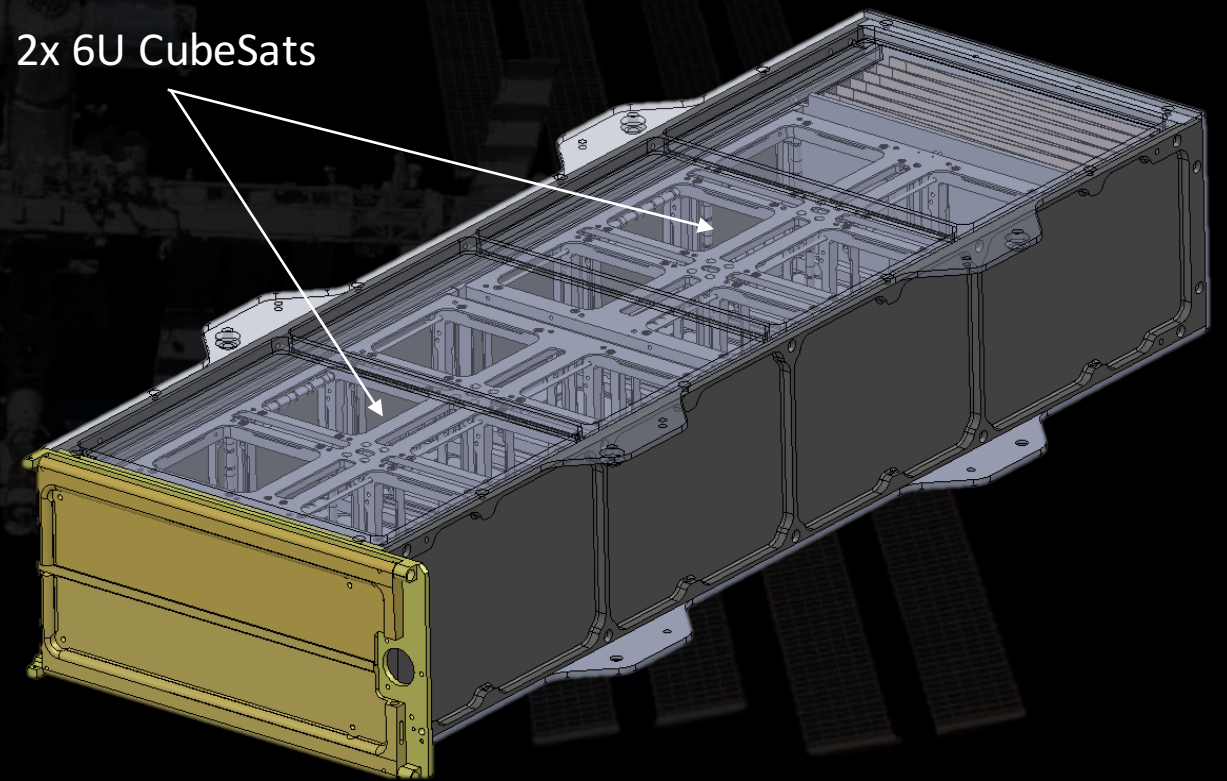

2x 6U CubeSats

12U NRCSD

Schedule and Program Requirements



- Scheduling (L-/+ months)
 - L-9 Initial data call
 - L-3 Safety Review
 - L-1.5 Customer delivery
 - L-1 NanoRacks deliver to NASA
 - L+1.5 Deployment (typical)
- NanoRacks Requirements
 - Battery flight acceptance test
 - Electrical: 3 inhibits minimum
 - Customer responsible for spectrum & remote sensing licensing
 - Fault-tolerance for deployables
 - Non/low toxicity materials
 - Secondary locking features

Acknowledgement

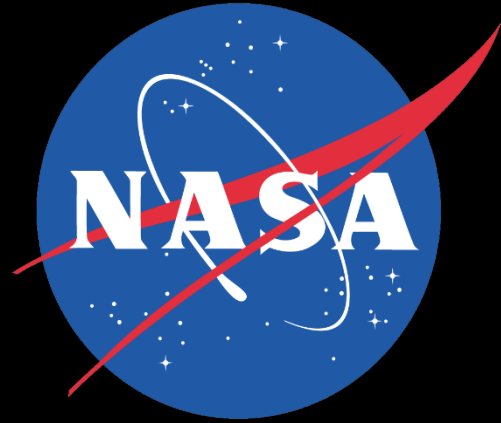

Customers!



NANORACKS



Contact:

Conor Brown

cbrown@nanoracks.com

703.973.6821