



Small Satellite Cluster Inter-Connectivity

Radhika Radhakrishnan (Ph.D. Candidate)

Dr. William E Edmonson (Ph.D. Advisor)

Dr. Qing-An Zeng (Ph.D. Co-Advisor)

North Carolina A&T State University

Greensboro, North Carolina, USA

Outline

- Introduction
- Enabling Operations
- OSI Model
- Network Design Issues
- Formation Flying Patterns
- System Parameters
- MAC and Routing Protocols
- Simulation
- Challenges and Future Work

Introduction

- Motivation
 - Provide inter-satellite communication over a distributed network of small satellites
 - Formation flying spacecraft
 - Satellite constellations
 - Fractionated spacecraft
 - Satellite swarms
- Objectives
 - Increased temporal and spatial resolution
 - Re-configurability
 - Distributed processing
 - Servicing/proximity operations

Enabling Operations

- Navigation and formation control
- Clock synchronization
- Eliminates the use of extensive ground based relay system
- Attitude control
- Identify the positions of individual satellites

OSI Model

Motivation – Allows any two systems to communicate regardless of their underlying architecture

Research Concentration – Layer 2 ; Medium access control

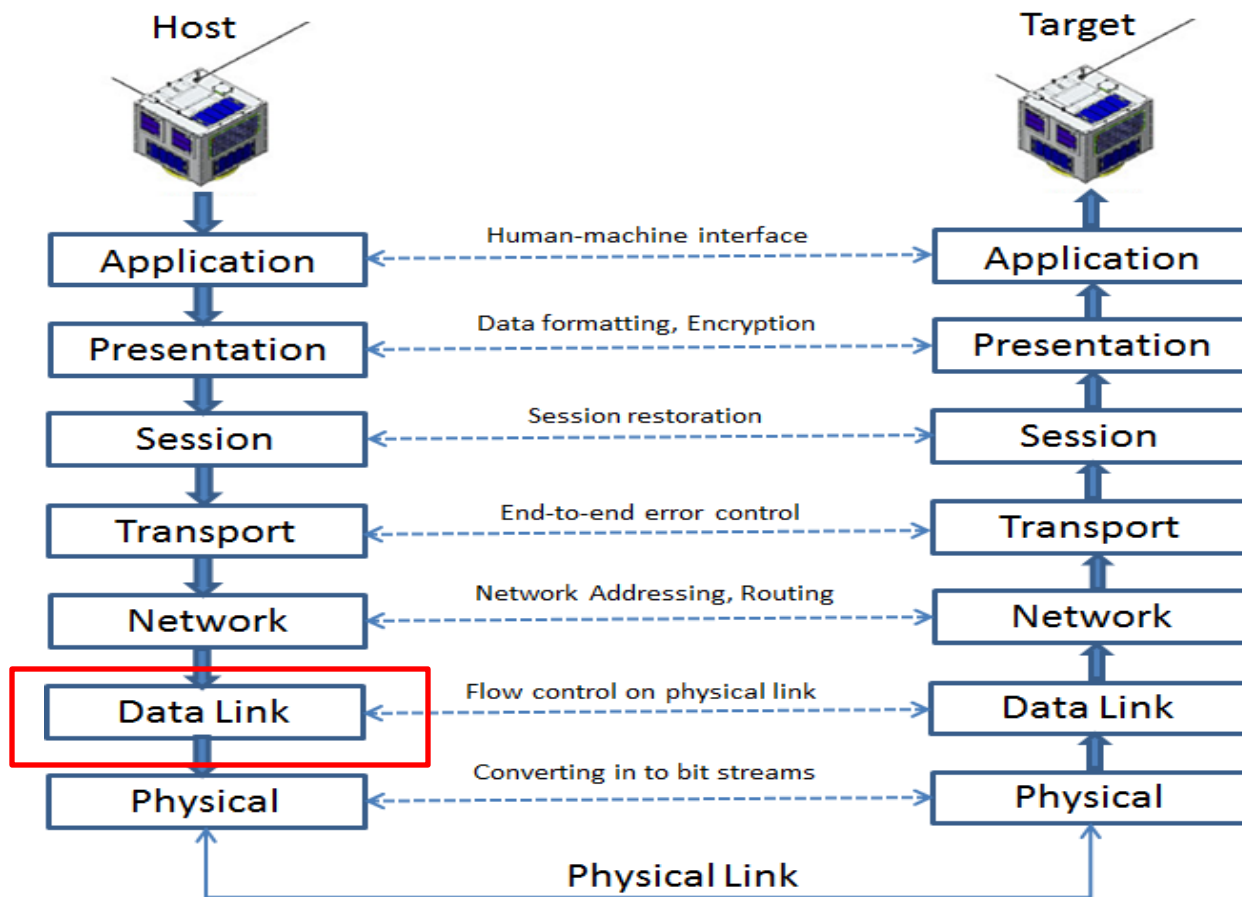

Network Design Issues

Layer 1/Layer 2:

- Radiation
- Solar storms— affect connectivity between satellites

Layer 2/Layer 3:

- Error free transmission
- Optimized routing approaches

Layer 4 and Above:

- Re-configurability
- Minimum power usage
- Reduce communication overhead

Formation Flying Patterns

Three types

- Leader Follower (A-Train)
- Cluster
- Constellation

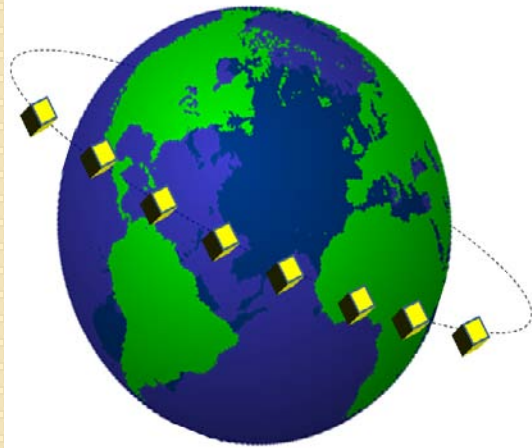

System Parameters

Our proposed system model is based on the following facts

- Transmission power – 500 mW to 2 W
- Deployed at an altitude of 300 Km
- Operates at S-band frequency (ISM Band, 2 GHz - 4 GHz)
- Transmission range – 10 Km to 25 Km
- For Cluster, separation distance between the satellites in different orbits are no wider than 2 Km

MAC Protocols

- Carrier Sense Multiple Access/Collision Avoidance (CSMA/CA) with RTS/CTS

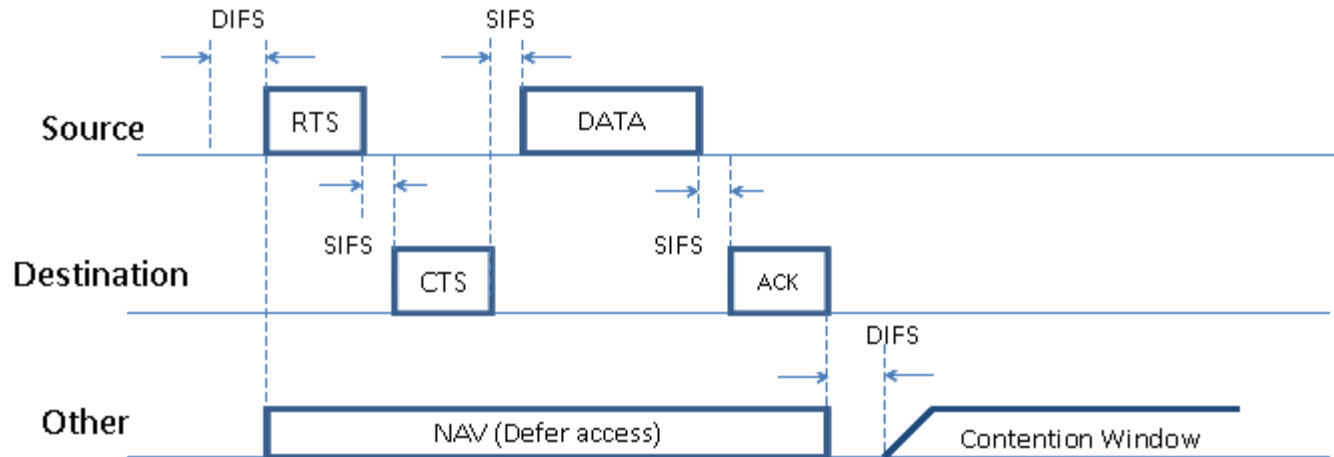

- Sender send RTS with reservation parameter after waiting for DIFS
- Receiver acknowledge via CTS after SIFS (if ready to receive)
- Sender can now send data at once, acknowledgement via ACK
- Other stations save medium reservations distributed via RTS and CTS.

MAC Protocols

- For Leader-Follower, use bi-directional antennas for control frames (RTS/CTS) and directional antennas for data frame
- For Cluster and Constellation, use omni-directional antenna for control frames and directional antennas for data frame
- Use smart antennas in the physical layer

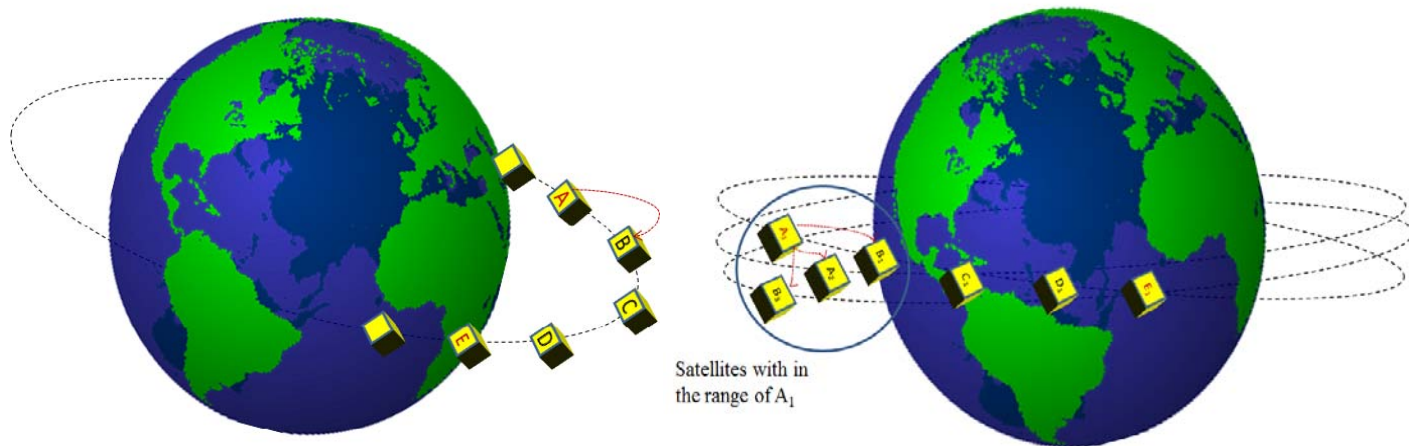

Routing Protocols

- Two types:
 - Proactive/Table driven
 - Reactive
- Reactive routing protocol is proposed
- Routing of packets based on shortest path algorithm

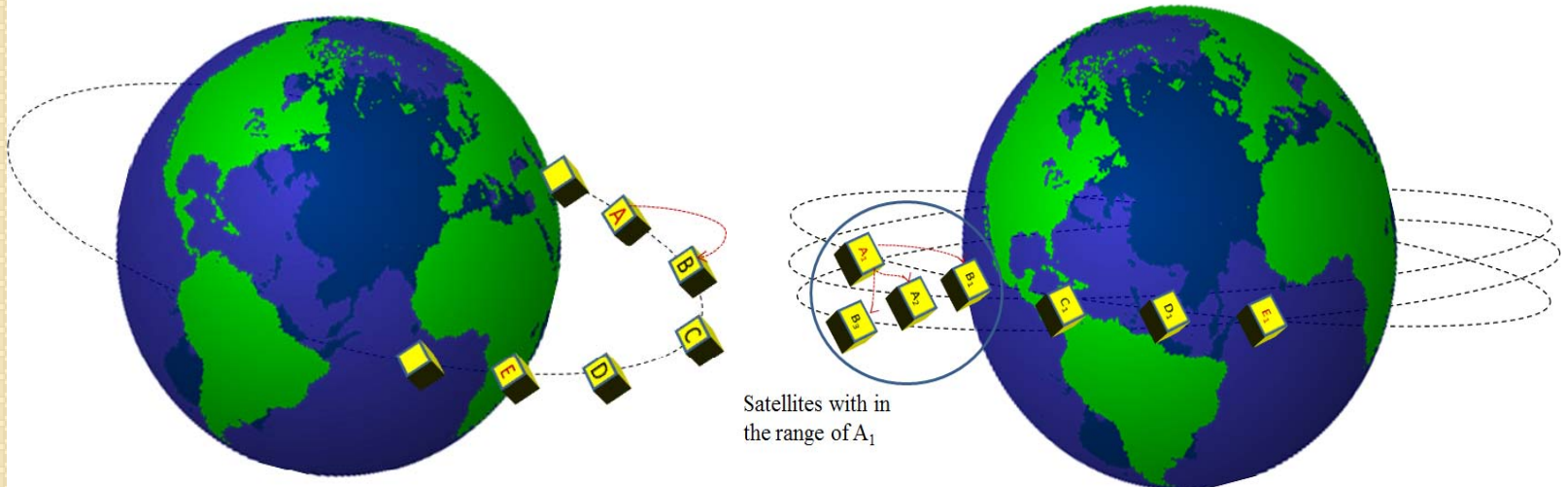

Simulation Model

- Simulator – Event driven simulator
- Arrival of packets follow Poisson distribution
- Data packet length follows exponential distribution
- DIFS = 28 μ s
- SIFS = 14 μ s
- Transmission power = 500 mW
- Transmission range = 8 Km
- System was evaluated using three different parameters – throughput, average access delay, and average end-to-end delay
- For both the systems, we simulated for an average of 200 data packets per satellite

Simulation Results

- Average access delay, Average end-to-end delay and Throughput

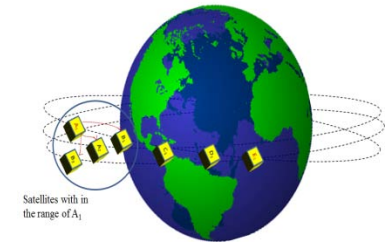
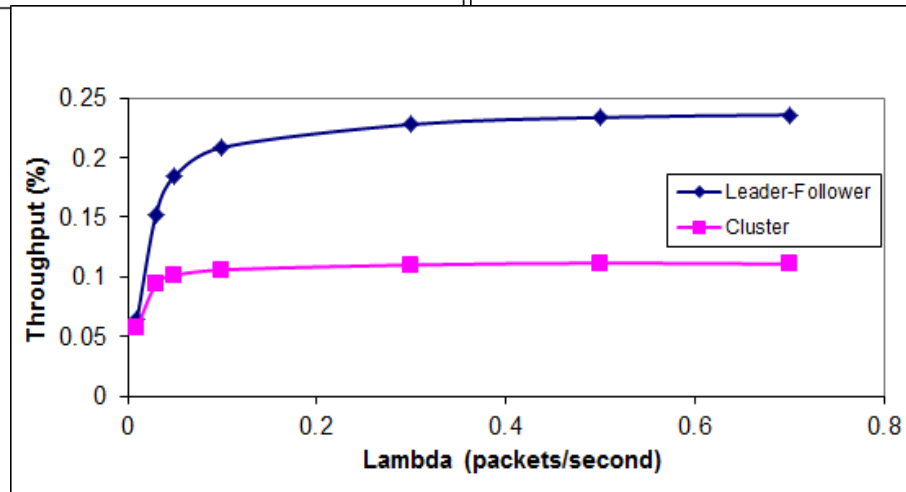
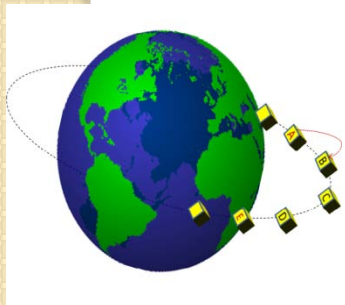
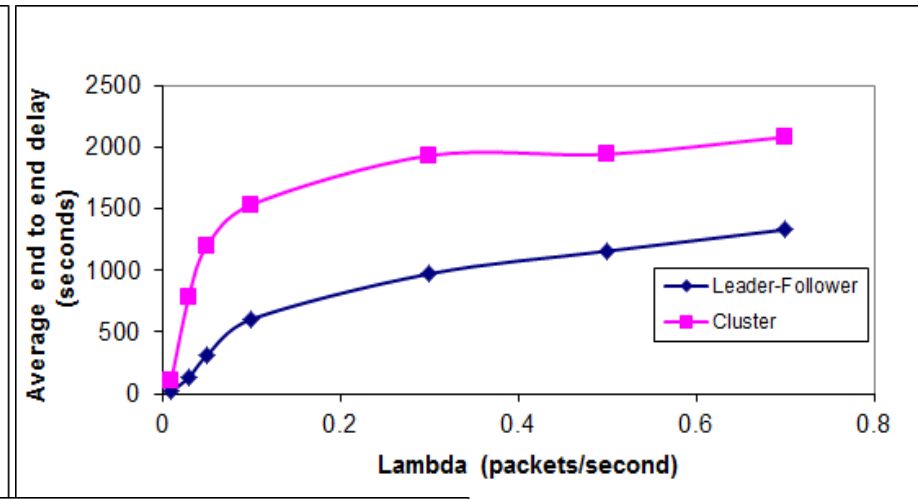
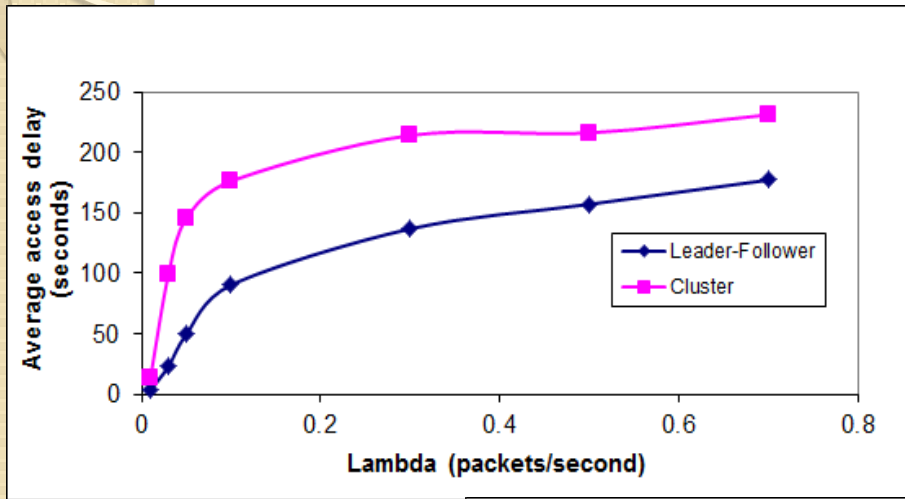

Conclusions

- Maximum throughput for Leader-Follower = 23%
- Maximum throughput for Cluster = 11%
- Average access delay and end-to-end delay are less for Leader-Follower compared to Cluster
- Proposed protocol ensures faster communication, higher data rate with low cost

Challenges

- Communication overhead is minimal
- Design protocols in such a way that communication module uses minimal over all power
- Maximum throughput

Future Work

- Simulate the MAC and routing protocols for the constellation formation flying pattern
- To build a test-bed

Acknowledgements

We would like to acknowledge the NSF for the support that was provided for this research effort through the I/UCRC Advanced Space Technologies Research and Engineering Center

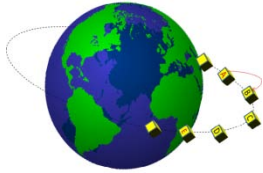

QUESTIONS

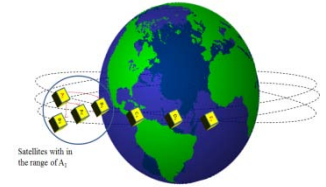



Thank You