



2011 Summer CubeSat Developers' Workshop

“Improving the Pointing Performance of CubeSats”

Stefano Redi, J. Barrington Brown, M. Pastena, G. Aglietti

August 6-7, 2011

Utah State University Campus - Logan, UT, USA

Outline:

- **Company Overview**
 - Space Segment
- **CubeSat Sun Sensor**
 - Features and Performance
- **ADCS Subsystem**
 - Components
- **Conclusions**

Company Overview:

- Established as Satellite Services BV (SSBV) in 1985
- Operating for over 25 years
- Focus on the International Space Industry
- Headquarters in The Netherlands
- Main Subsidiary in United Kingdom
- Multi-national organisation
- Flexibility
- High-performance
- Cost-effective

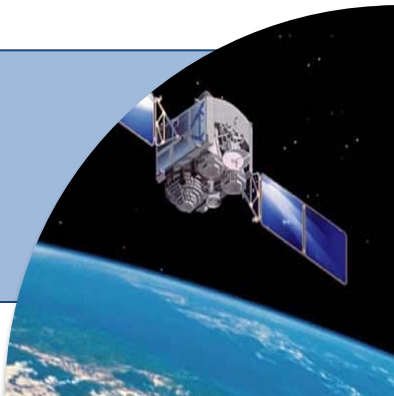

Areas & Activities

- 
- Smallsat Sensors
 - Smallsat Sub-Systems
 - Mini-SAR sensor
 - PowerFFT
 - Purpose Built Microsats

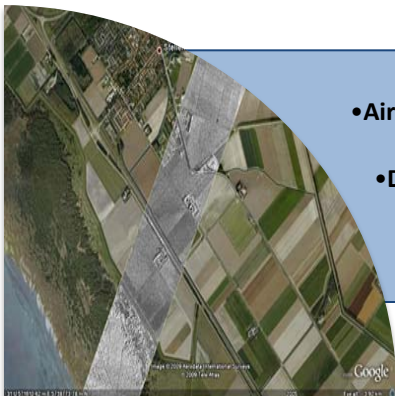
- 
- Airborne & Space based Sensing
 - Ground Station Hosting
 - Data reception & TTC Services
 - Data (pre) Processing
 - Test Services

- 
- EGSE / SCOE
 - Special Test Benches
 - Payload/Platform Simulators
 - Real-Time Simulators (HIL)
 - Avionics, Power, TM/TC & RF Testing

- 
- EO / TTC Ground Stations
 - TTC & High-Rate Modems
 - SIGINT Data recorders
 - Data ingest/Processing
 - Spectrum Monitoring



Fine Sun Sensor



Cubesat Sun-Sensor

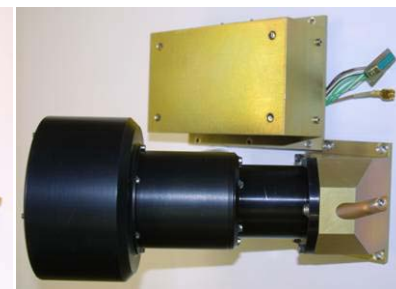

Star Mapper



Earth Horizon Sensor

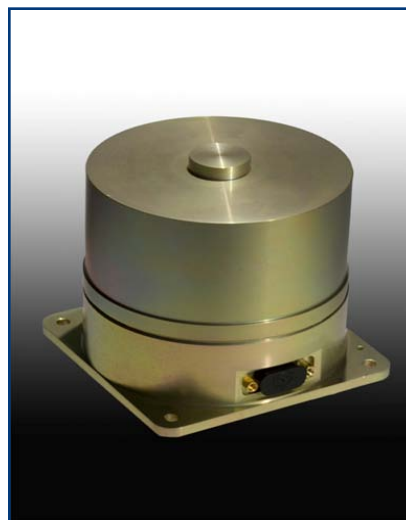

Reaction Wheel

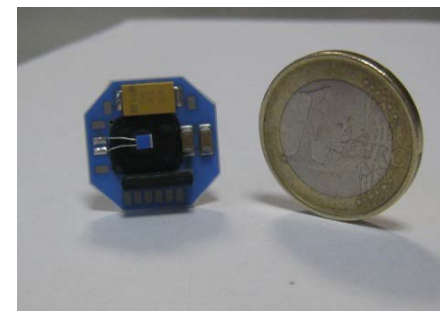

Magnetometer

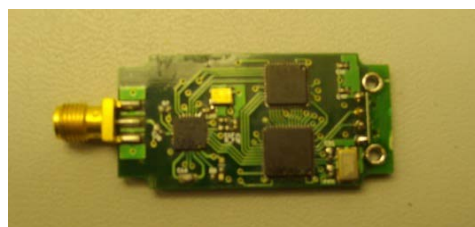

GPS Receiver

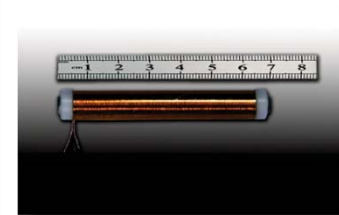

Magnetorquer Rods

Cubesat Sun Sensor:

- Pinhole Camera
- Position Sensitive Detector
- Technical Simplicity
- Off the Shelf Components
- Small Size
- Low Cost
- Competitive Levels of Accuracy and Resolution

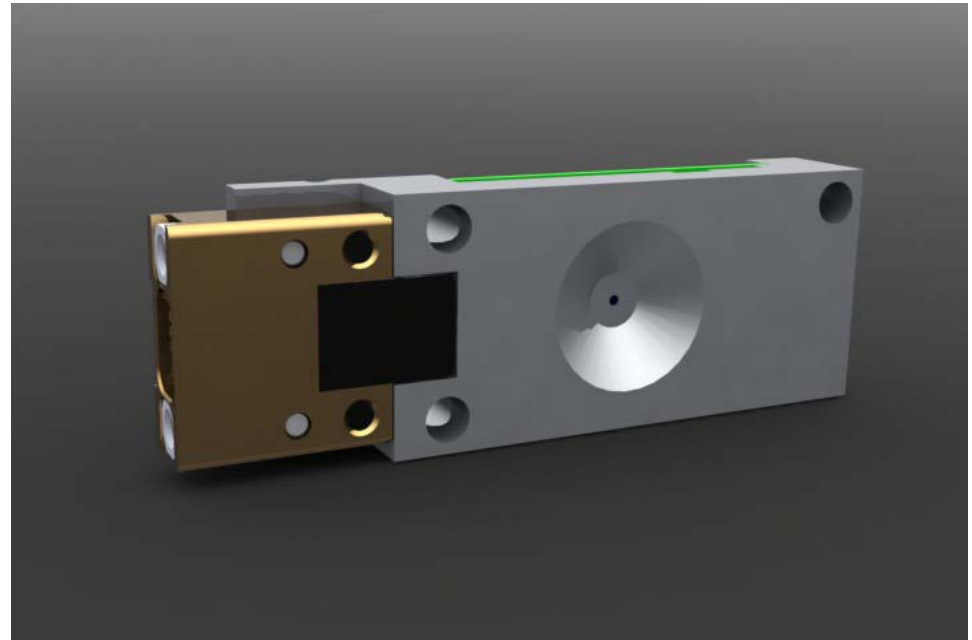

Cubesat Sun Sensor:

- **Dark Chamber**
 - Metal Shield
 - Enclosure for the Detector
- **Mechanical Tolerances**
 - Detector Alignment
- **Thermal Issues**
 - Surface Treatments
 - Conductive Path

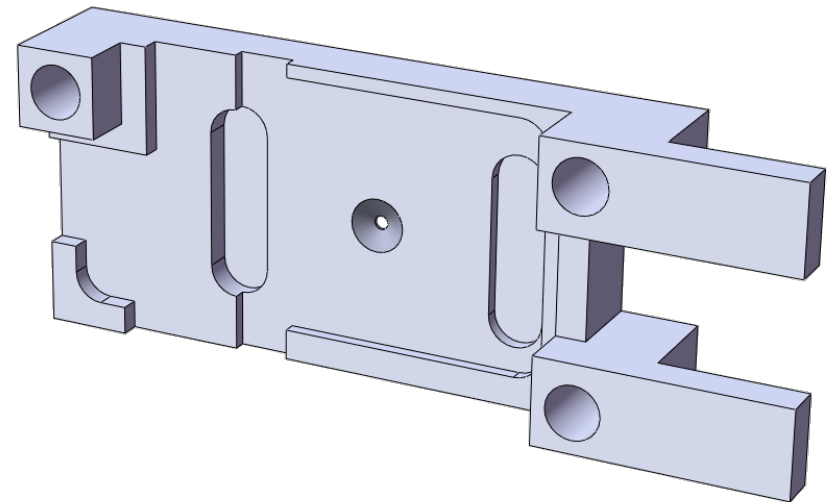
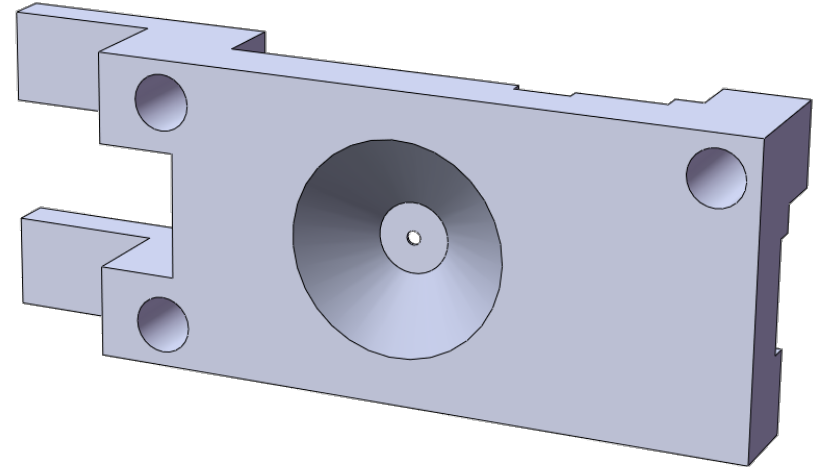

Cubesat Sun Sensor:

- **Output**
 - Current Conversion into Voltages
 - Simple Electronic Interface
- **Calibration Algorithm**
 - Voltages Conversion into Sun Vector
 - Accuracy of +/-0.2 degrees

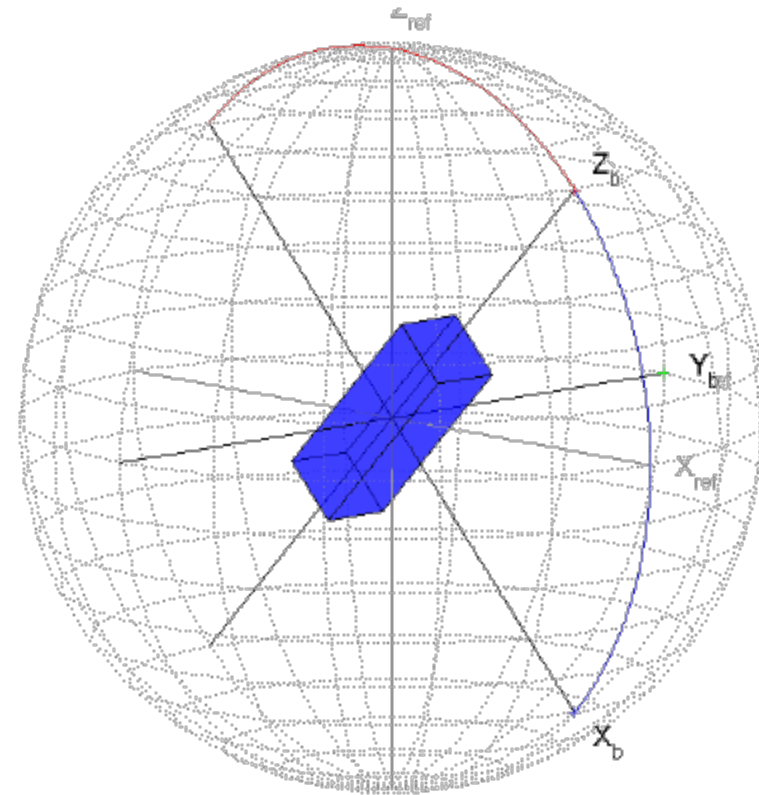

Sun Sensor Calibration:

- **Optical Table**
 - Collimated Light
 - Optical Path
 - Mirrors at 45°
 - Translational Stages
 - Rotary Stages

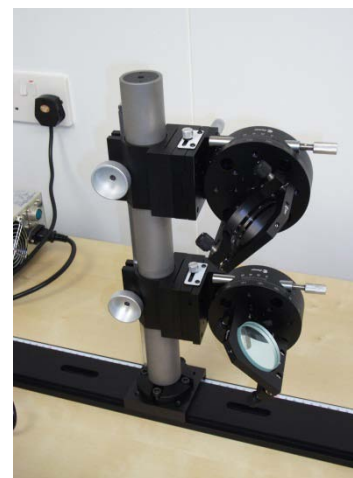
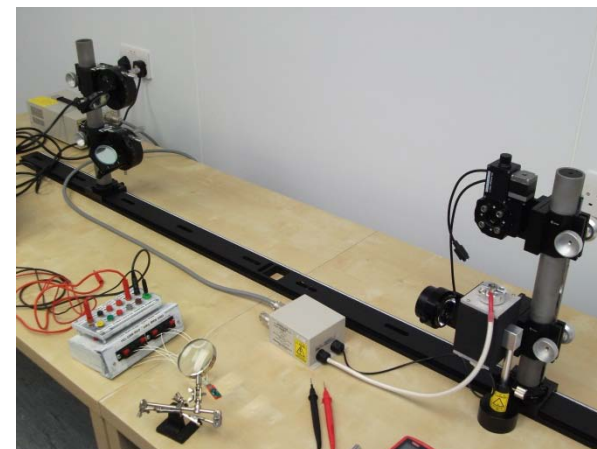

Ukube-1:

- Scheduled for 2012
- Platform provided by Clyde Space
- Competition for Payloads
- Technology Test
- Quick and Efficient Space Research
- Pilot for Full National CubeSat Program



ADCS Board:

- **Sensors**

- 6 Sun-Sensors
- Magnetometer
- 3 MEMS Rate Sensors
- Stellar Gyro
- GPS Receiver

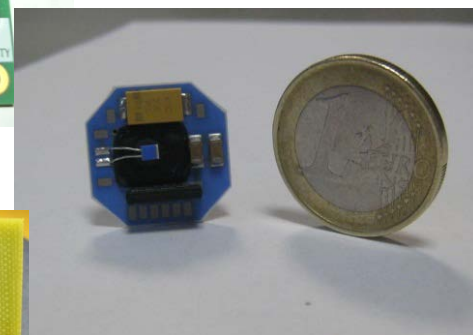

- **Actuators**

- 3 Torquerods
- (Momentum Wheel)

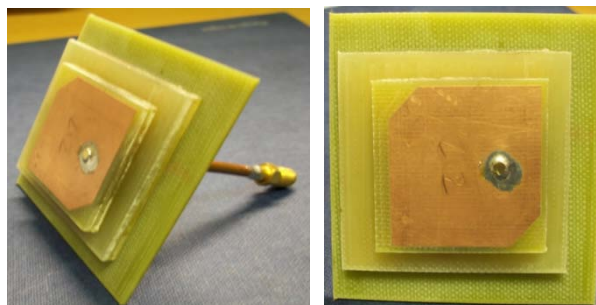

- **3 Axis Attitude Determination and Control**

- **Due to Fly on TechDemoSat-1 in 2012**

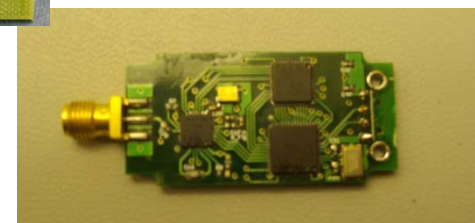

Conclusions:

- **CubeSat Sun Sensor**
 - Main Features
 - High Accuracy Pointing Solution for CubeSats Missions
 - ADCS Board Integration
- **University/Industry Collaboration**
 - High Level of Innovation, Technology and Research
 - Potential Requirements of the Scientific Community
 - Releasing the potential of CubeSats Missions

A blue-tinted view of Earth from space, showing the curvature of the planet and the atmosphere. The text "Thank You for Your Attention" is overlaid in white. The background is a dark blue space filled with numerous small, bright stars.

Thank You for Your Attention

SSBV

**SSBV Space and Ground Systems
Building 1, Anchorage Park
Robinson Way, Portsmouth
PO3 5SA, United Kingdom**

Tel: +44 2392 626300

Fax: +44 2392 626348

www.ssbv.com

**contact:
Marketing@ssbv.com**