

WWW.INTERORBITAL.COM

Interorbital Systems' NEPTUNE Modular Rockets: Launching the World's Small Sat Payloads!



Interorbital Systems
www.interorbital.com



About Interorbital Systems



- Founded in 1996 by Roderick and Randa Milliron
- End-to-end rocket R&D, testing, and manufacturing facilities
- Two operational rocket engine test sites
- Location: Mojave Spaceport in California
- Seeking US Permission to Conduct Orbital Launch Operations (land) at IOS' Proposed Private Spaceport, Kingdom of Tonga (pending export control approval)
- Orbital Launch Operations (ocean): Worldwide. Primary: 160 miles off the California Coast
- Considering orbital operations from Wallops, Kodiak, and New Mexico (sounding rockets)



Interorbital Systems

www.interorbital.com



Pressure-Fed Rocket Engines Since 1995

GPRE 2.5KLMA Liquid Oxygen/Methanol Engine: Thrust = 2,500 lbs.

GPRE 0.5KNFA WFNA/Furfuryl Alcohol (Hypergolic): Thrust = 500 lbs.

GPRE 0.5KNHXA WFNA/Turpentine (Hypergolic): Thrust = 500 lbs.

GPRE 3.0KNFA WFNA/Furfuryl Alcohol (Hypergolic): Thrust = 3,000 lbs.

GPRE 6.0KNHXA WFNA/Turpentine (Hypergolic): Thrust = 6,000 lbs.

GPRE 10.0KNHXA WFNA/Turpentine (Hypergolic): Thrust = 10,000 lbs.



Pressure-Fed Sounding Rockets Since 1999

Neutrino: GPRE 0.5NFA Engine

Tachyon: GPRE 3.0KNHXA Engine

CPMTV: GPRE 6.0NHXA Engine

CPM SR145: GPRE 6.0NHXA Engine



Manned Systems

Dick Rutan's Global Hilton Project

Helium/Hot Air Balloon System Propane Tanks



Environmentally Safe, Storable, High-Density Hypergolic Propellants

White Fuming Nitric Acid (WFNA) and Turpentine/Furfuryl Alcohol
Renewable Fuels derived from Pine Trees and Oat Hulls
Instantaneous chemical ignition eliminates need for complex ignition system

Low-Cost Propellant Tank Technology

Custom aluminum tank liners and tank ends
State-of-the-art composite tank reinforcement technology

Blowdown Propellant Feed

Eliminates the need for turbopumps or a separate pressurant system

Unique Rocket Engine Injector

Automatically maintains propellant jet flow rate in blowdown mode
Maximizes specific impulse over a wide pressure input range

Modular Rocket System – The Common Propulsion Module (CPM)

Low-thrust rocket engines 6,000-10,000lb-thrust engines
Smaller engines equal low-cost rocket engine development
Small diameter tanks; slosh baffles not required
Individual rocket modules can be flight tested at a very low cost
Launch vehicle can be customized for any payload by adding modules
Designed for assembly-line mass production





- The Common Propulsion Module (CPM) is the basic building block of the N-Series Rockets
- Bi-propellant storable, hypergolic liquid rocket system
- Blowdown propellant feed
- State-of-the-art composite propellant tanks
- Throttleable, ablatively-cooled rocket engines
- CPMs clustered together in multiples to meet mission requirements

Common Propulsion Module (CPM)



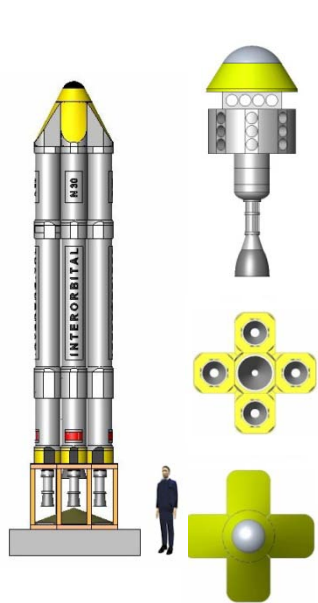

N30 (5 CPMs)

Payload = 30 kg

3 stages

NanoSat Challenge

Olav Zipser High-Altitude
Record Jumps

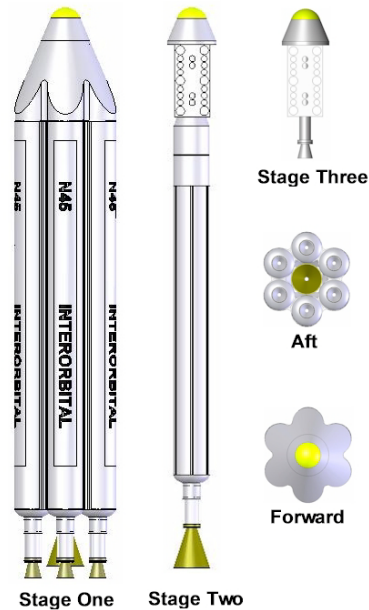

N45 (7 CPMs)/ N70(9CPMs)

Payload = 45 kg; 70 kg

3 stages

NanoSat Challenge

Interorbital Systems

www.interorbital.com

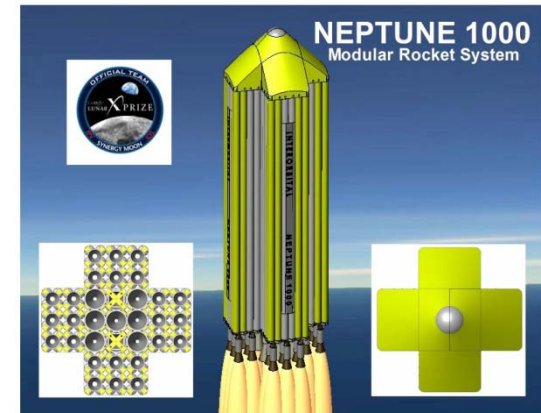

N1000 (36 CPMs)

Payload = 1,000 kg LEO/ 60kg
Lunar Surface

4 stages

GLXP/SYNERGY MOON

Orbital Tourism Rocket

Two-Crew Capsule, 8 orbits



- Portable, dedicated small sat launchers
- Easy to transport on highways, ocean, or by air in standard 40-foot cargo container
- Can be launched from land or sea
- Launched from land from a Mobile Launch System
- Launched from the ocean using the Floating Launch or Platform System
- Storable Propellants/Launch-on-Demand
- Ultra low-cost, rapid access to space
- Four Orbital Missions planned for 2012, including NanoSat Challenge Flights



CPM TV: Common Propulsion Module Test Vehicle

Low-altitude unguided flight (1) Summer, 2011
(25,000-35,000 ft) FAA Class 3 Waiver

Low-altitude guided flights (2) Autumn, 2011
(25,000-50,000 ft) FAA Class 3 Waiver

Payloads On-Board:

- Morehead State University, Kentucky**
- Naval Postgraduate School, California**
- King Abdullah University, Saudi Arabia**





- A full-service mobile rocket launcher
- Hydraulic lift system
- Automated propellant-fill hardware
- Mobile launch platform for IOS CPM SR145 sounding rocket program
Suborbital: 145 kg to 310 km





The \$8,000 Orbital Enabler (Special Academic & GLXP Price)

- PCB Gerber Files
- 50 Spectrolab TASC solar cells
- A Li-ion battery pack (3.7 V 5200 mAh)
- Microcomputer (NetMedia BasicX-24)
- Transceiver (Radiometrix)
- Antennas
- Fasteners
- Complete instructions and assembly guide

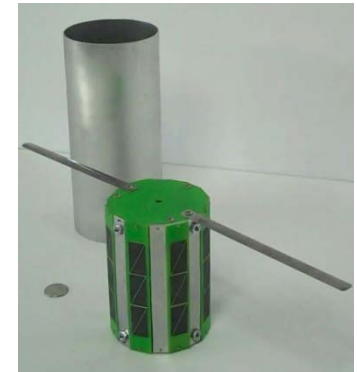
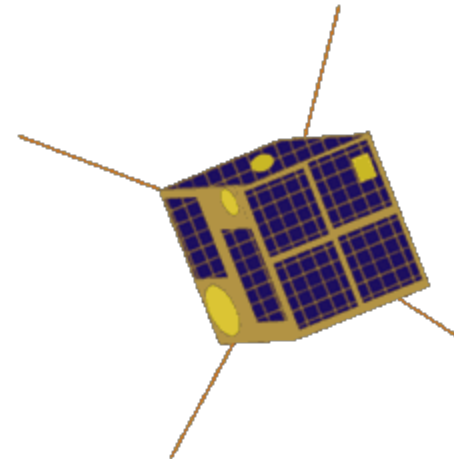

TubeSat with Sample Ejection Cylinder

**NEW!!! IOS CUBESAT KIT!!! 1kg Kit and Launch
\$15,000-\$20,000**



NEPTUNE Launch I Manifest, March 2012: SOLD OUT!



CubeSats

UC Irvine, UCISAT1

FPT University, Vietnam, F-1 CubeSat

Nanyang Technological University, Singapore

GLXP Team EuroLuna, Romit 1 (2-Unit CubeSat from Denmark)

GLXP Team Plan B (Canada)

King Abdullah University, Saudi Arabia (2 IOS CubeSats and 1 TubeSat)

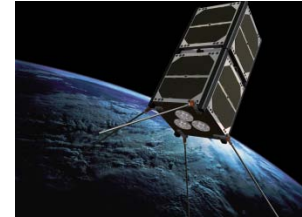

TubeSats (constructed from Interorbital Systems' TubeSat Kits):

Morehead State University (Kentucky Space)

InterAmerican University of Puerto Rico

University of Sydney (Australia) (2) i-INSPIRE Project

Aslan Academy (Private LA High School)

Project Calliope (Space Music Project)

Universidad de Puerto Rico / Marcelino Canino Middle School

GLXP Team SYNERGY MOON (US/International)

GLXP Team Part-Time Scientists / Fluid & Reason Software (2) (US/Germany)

Naval Postgraduate School (3) (TubeSats as ad-hoc orbital communication nodes)

Defense Science and Technology Lab (DSTL) United Kingdom

Austrian Arts Group mur.org

United States Military Academy at West Point (2)

Brazilian Space Institute /108 5th-7th Grade Students, Ubatuba, Sao Paulo, Brazil

Mexican Satellite Project : ULISES I Arts/Soccer Opera from Space

TriVector Services (Huntsville)

AKQA Advertising Agency , San Francisco

La Despensa (The Pantry) Advertising Agency/Iniciativas en Idiomas (Madrid, Spain)

Space Weather.com/ Bishop, CA, High School. iPod = Voyager's Golden Record

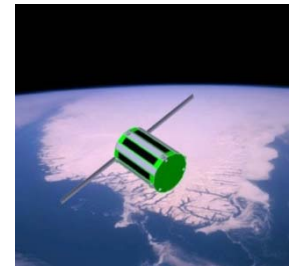

■Twenty additional projects with committed payloads are in various phases of funding. These include academic, arts, private-sector, military, and corporate groups from the US, Mexico, Singapore, Hungary, Japan, Germany, Pakistan, New Zealand, Chile, the Dominican Republic, Holland, France, and Lithuania.

Interorbital Systems

www.interorbital.com

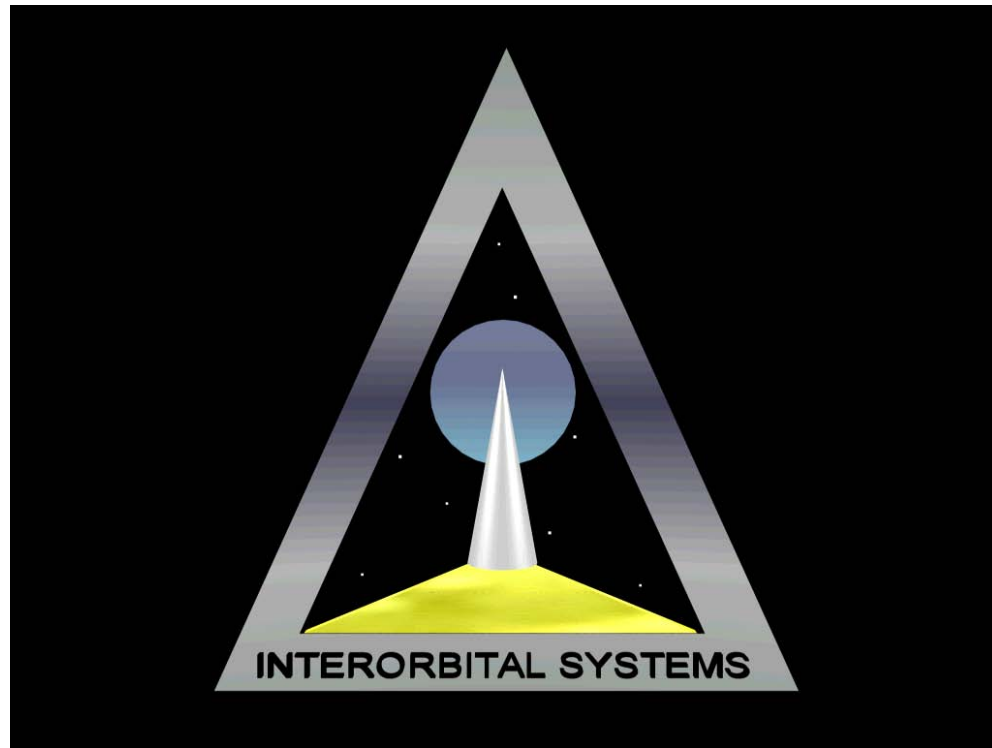

WWW.INTERORBITAL.COM