

ParkinsonSAT Remote Data Relay (Psat)

Cubesat Conference
August 2011

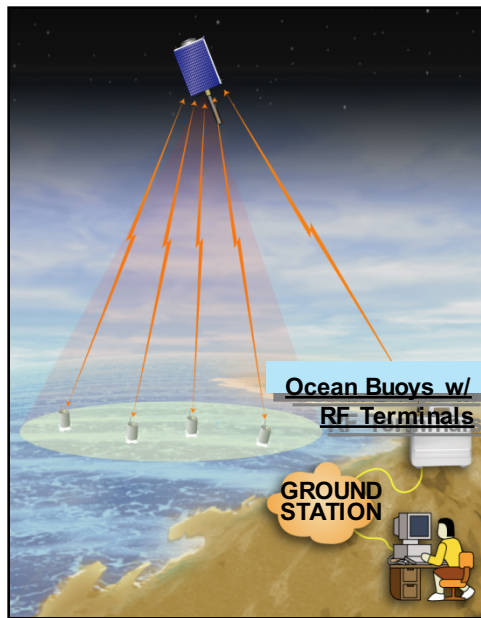

ODTML

Psat

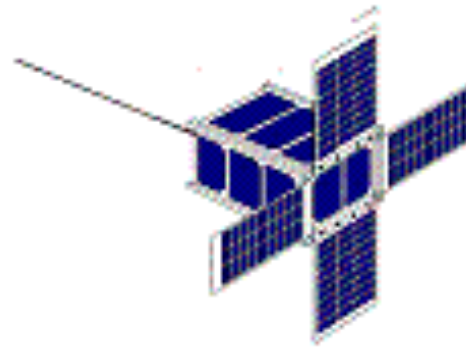

Bob Bruninga
*Midns: Crawford, Guilfoyle,
Lumsden, Randall, Pollock, Schlottmann*

*US Naval Academy Satellite Lab
410-293-6417
bruninga@usna.edu*



UNCLASS

ParkinsonSAT 1.5u CUBESAT

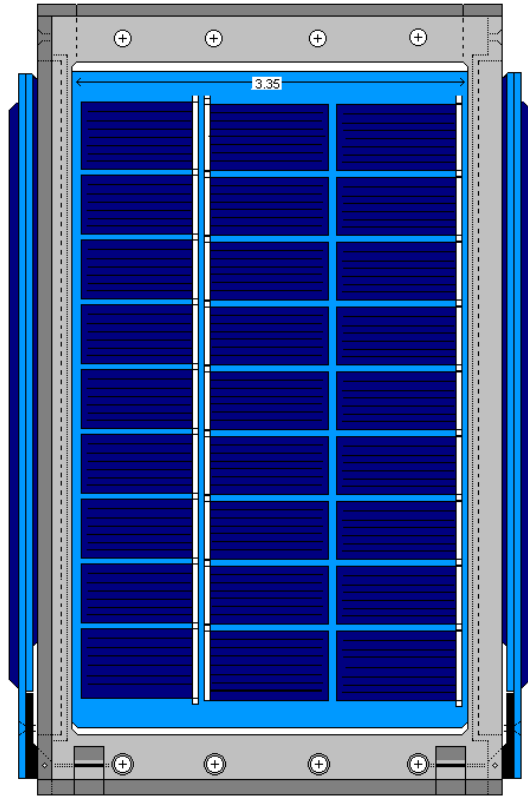

7"

Psat Xponder can also serve as complete comms & C&DH in a cubesat

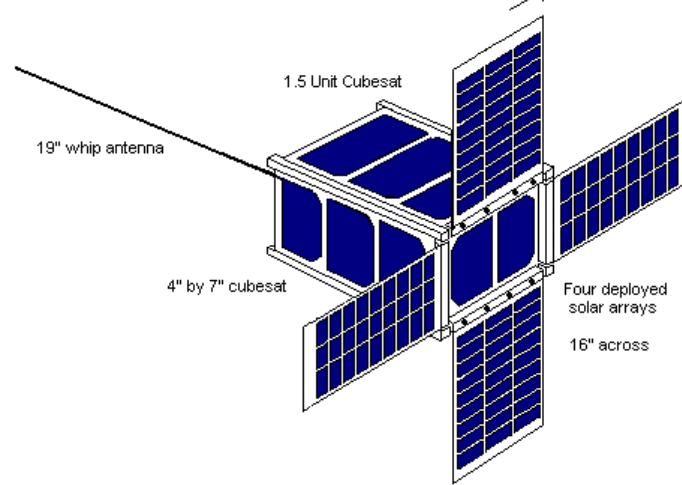

- New tiny 5W RF Xponder
- Simple Sun Pointing ADCS **\$50** Magnetometer
- Can support other SERB Payloads
- COTS solar panels **\$360 / (\$15,000)**

Psat Transponder Aux Payload

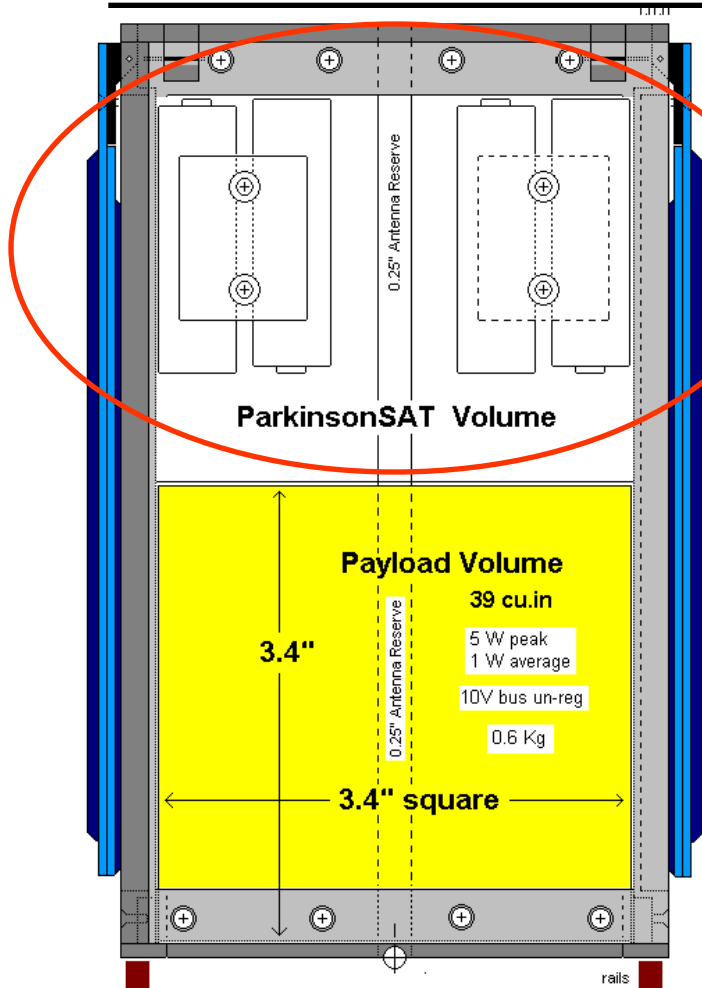
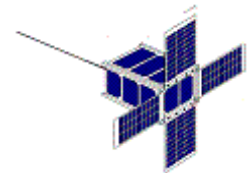

75% Payload Space Available! (only 50% shown here)

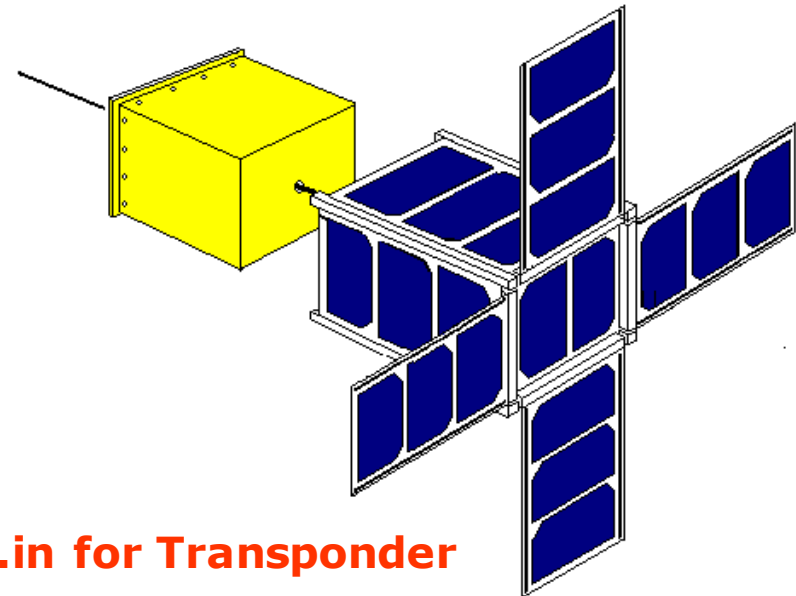

7"

- **18 cu.in for Transponder**
- **External 19" whip antenna**
- 68 cu.in for Aux Payload (SPMS?)
- Aux payload gets 4" external panel
- Aug payload gets .5 kg – self contained
- 1 to 3W average power for aux payload

Psat Structure (& Thermal)

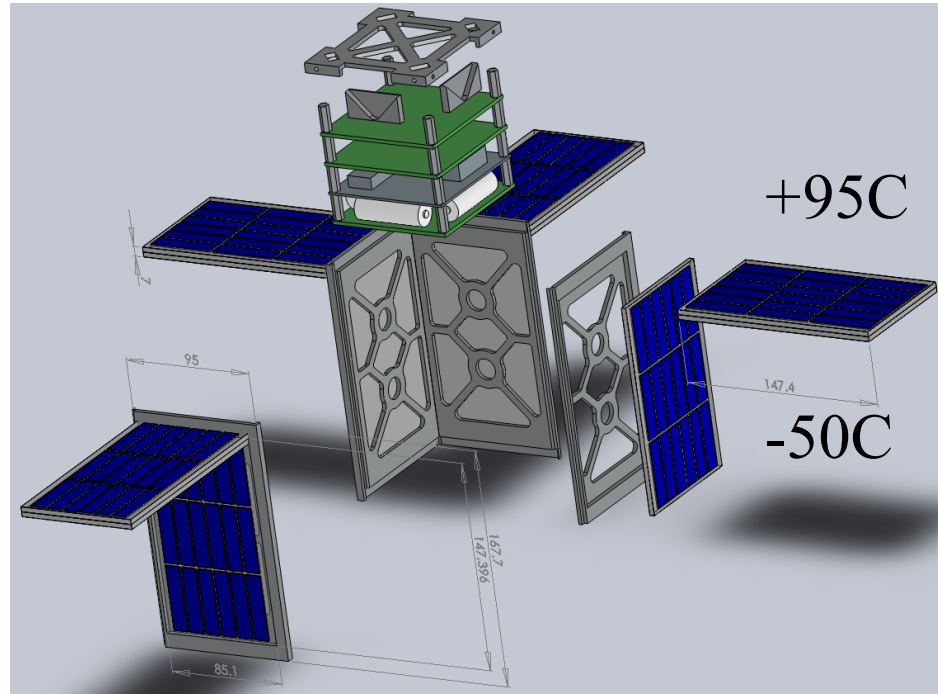
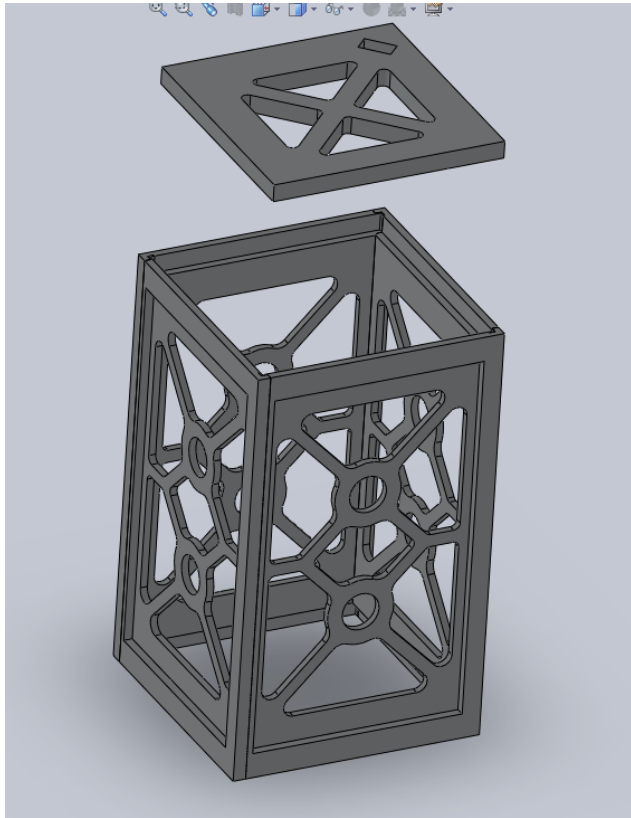

Was 0 C to 40 C on body

CUBESAT Deployment

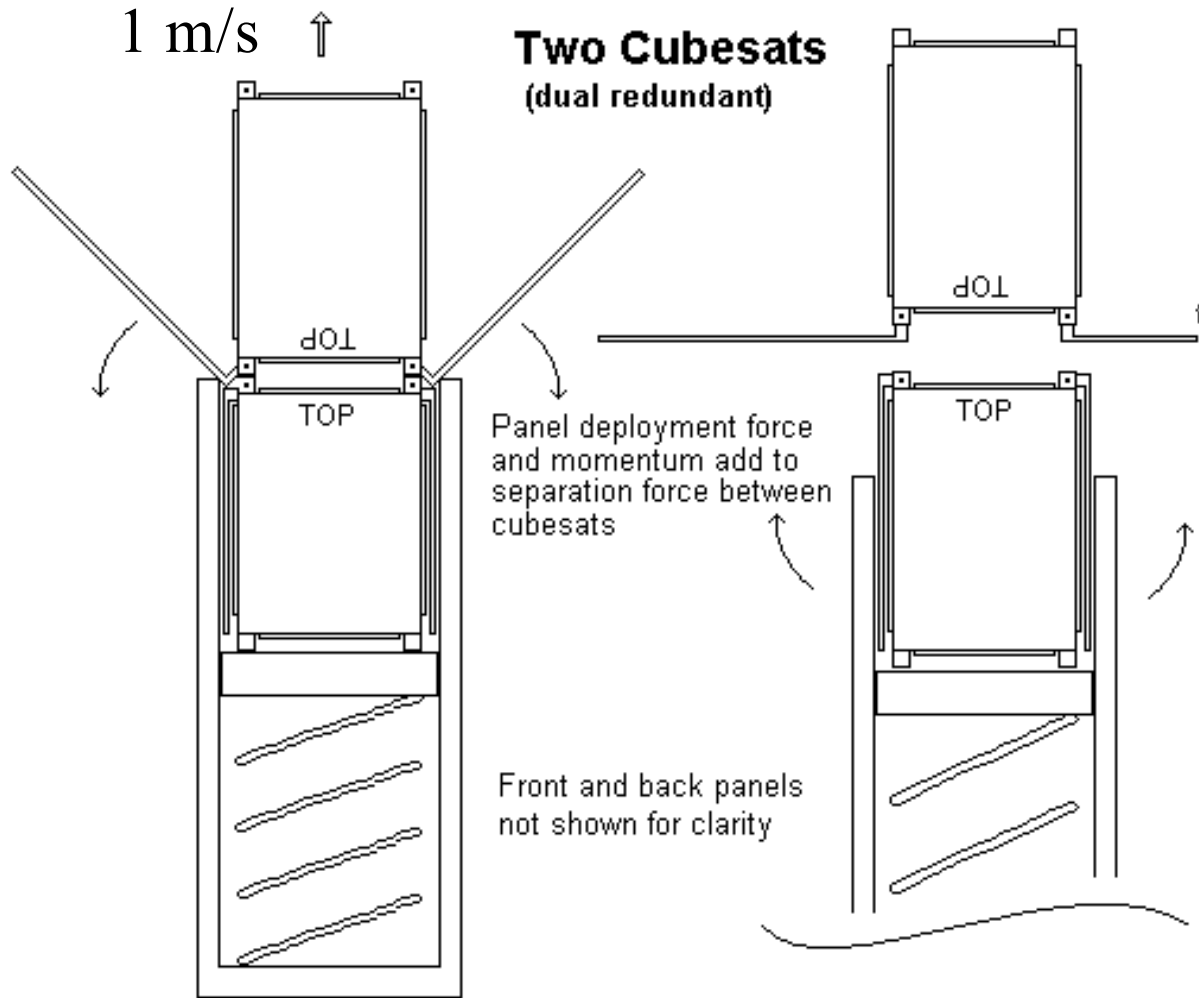

Psat
USNA-0601

Sun Pointing Attitude Control System

- ✓ Pointing requirements are relaxed +/- 32 deg for 85% power
- ✓ High precision attitude control not required

Sensors/ Magneto

http://www.sparkfun.com/commerce/product_info.php?products_id=244



MicroMag 3-Axis Magnetometer

SKU#: Sense-Mag3

Price: \$54.95

Description: PNI Corp's 3-axis magnetometer. Ready for the big time? Low noise, large resolution magnetic field sensing all packed into a user-friendly DIP module at your disposal. Stable over a wide temperature range, the MicroMag3 is a must have for orientation sensing and navigation.

Features:

- 500uA @ 3.3V DC
- Field measurement range +/-1100uT
- Resolution as low as 0.015uT
- SPI interface - no additional circuitry needed

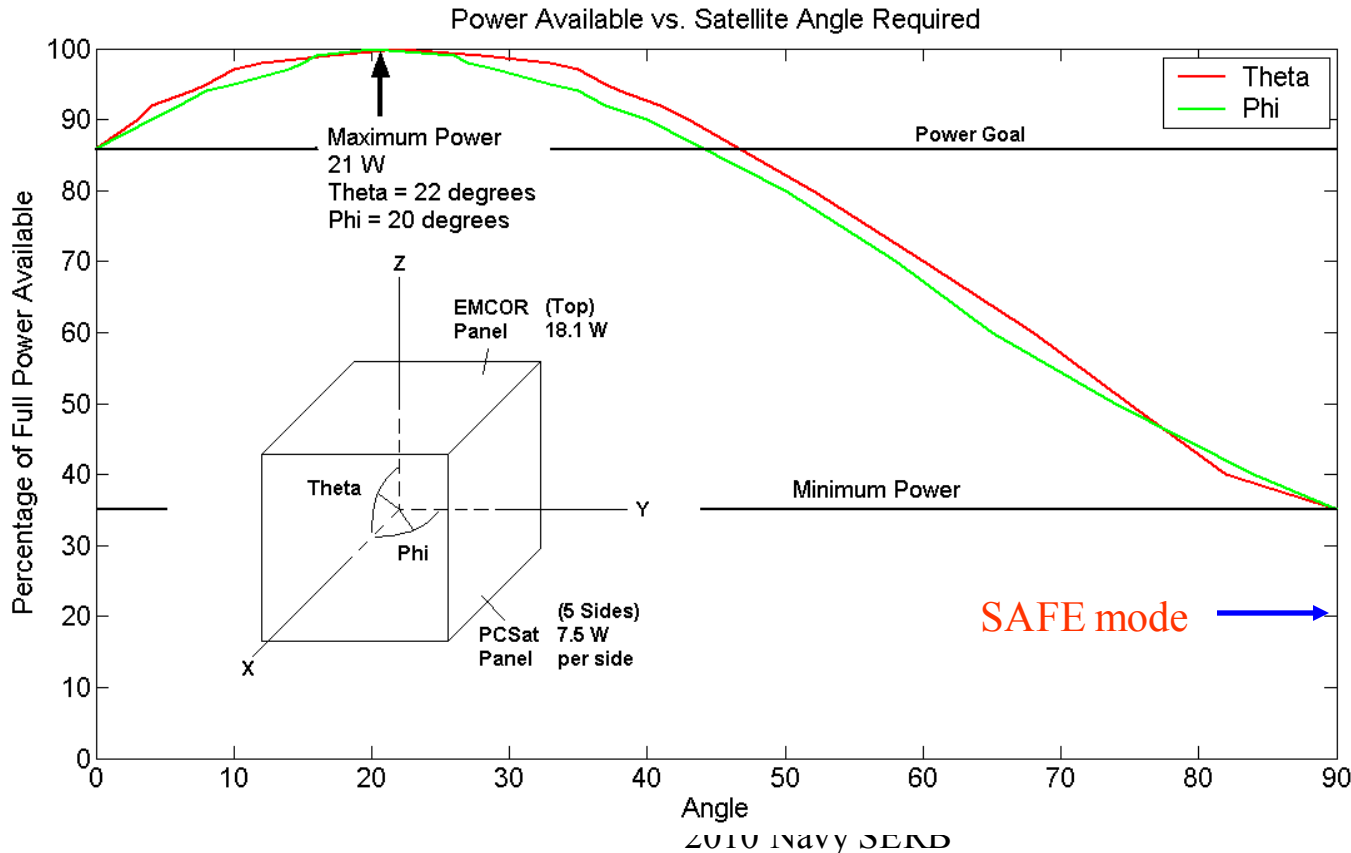

Cubesat

3.5W

1.5W

SAFE mode

Matlab Simulation of Modified B*dot

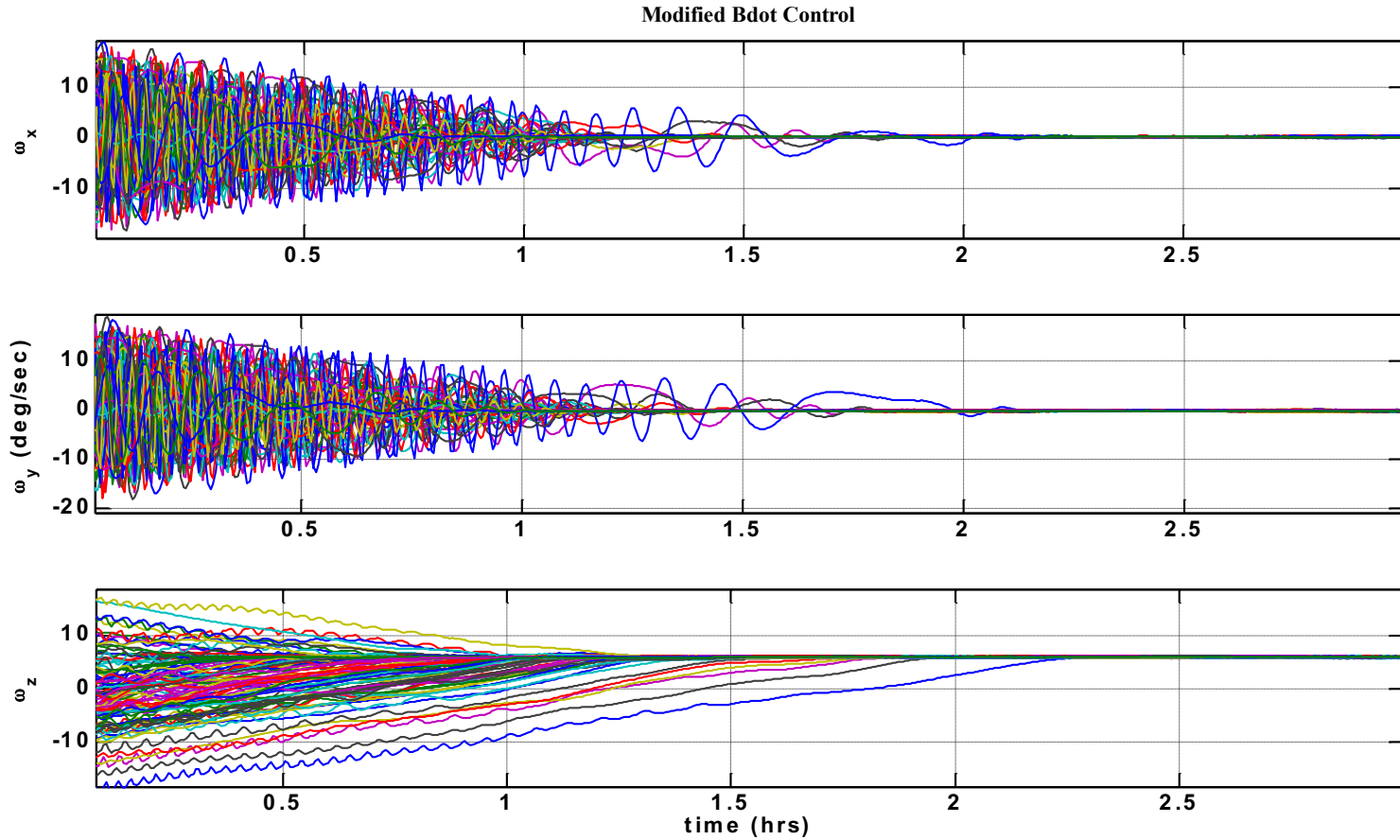

Ground Station Software

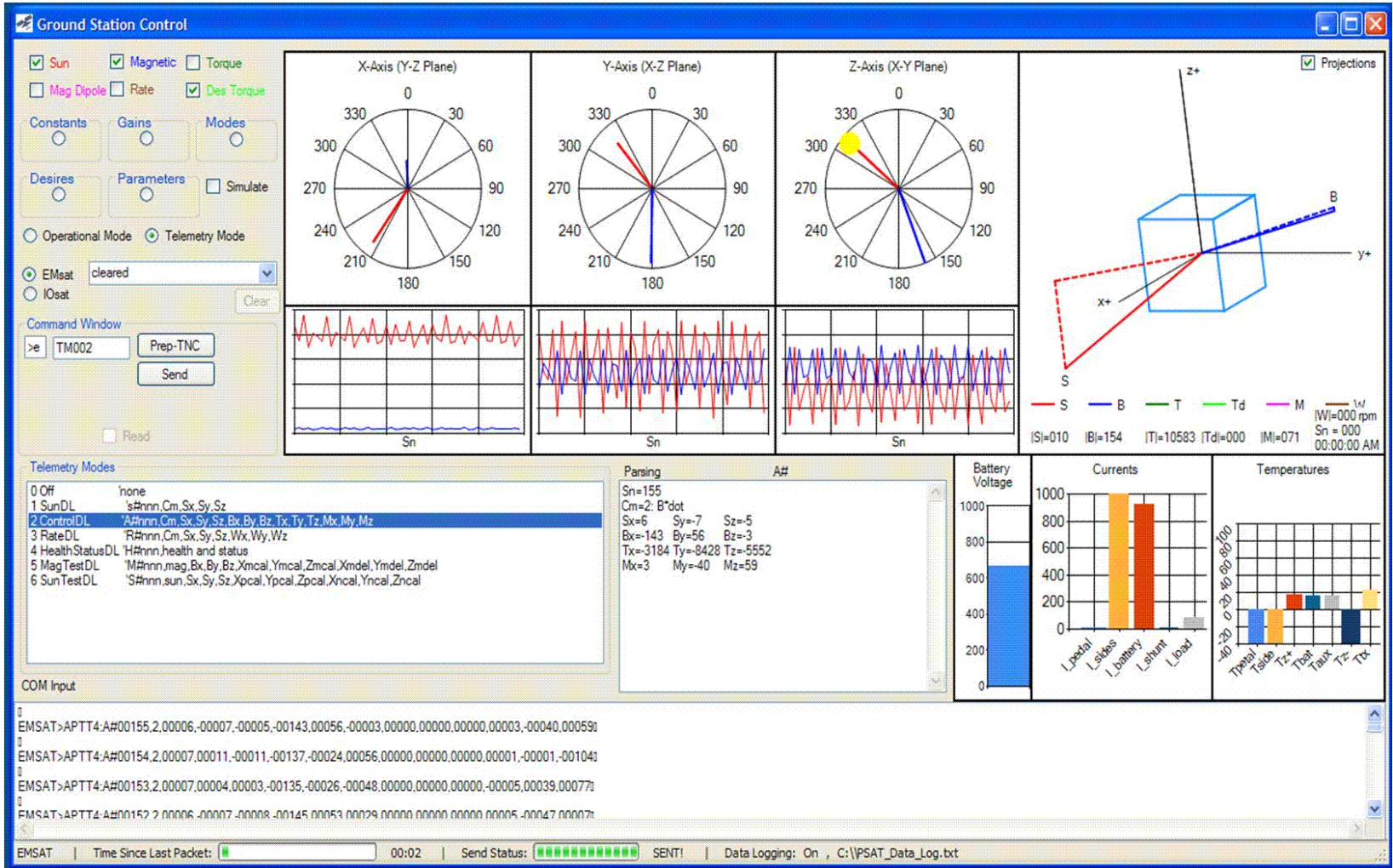
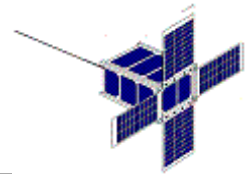

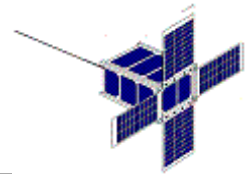

USNA Transponder Block Diagram

Cubesat #A

Now split between two cubesats

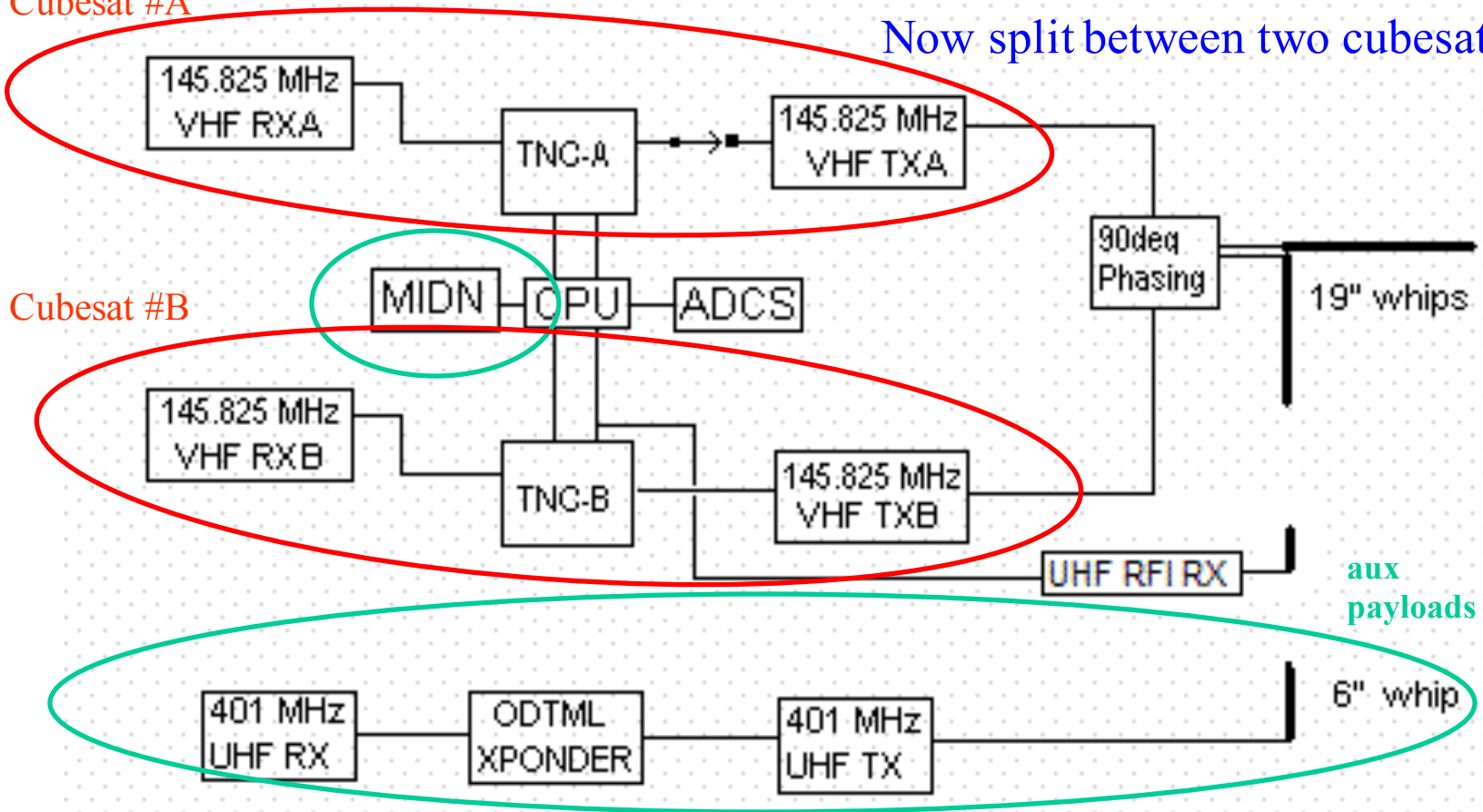

Huge reduction from transponders on PCSAT's 1,2, ANDE and RAFT missions

Posat USNA-0601

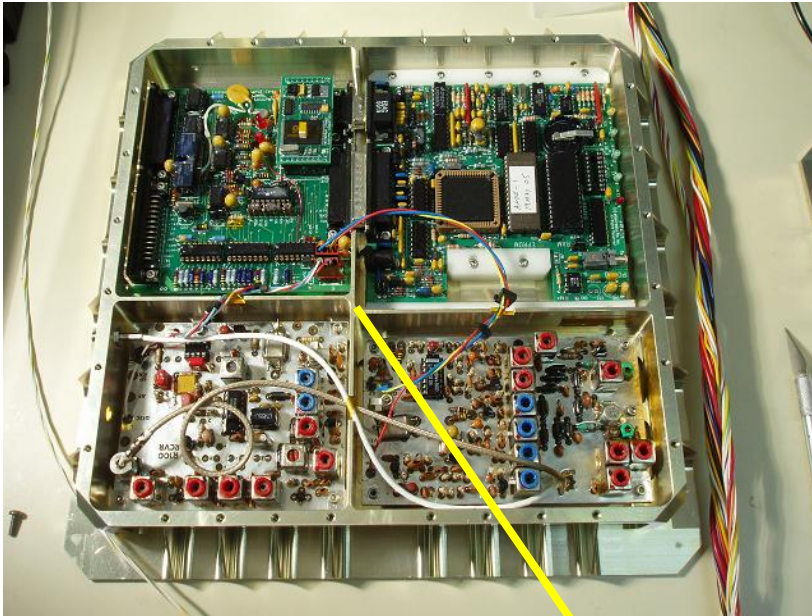

Earlier reductions to 5" cubesat on RAFT (2006)

4:1

Now reduced 18:1 in volume/mass for 4" cubesat 2009

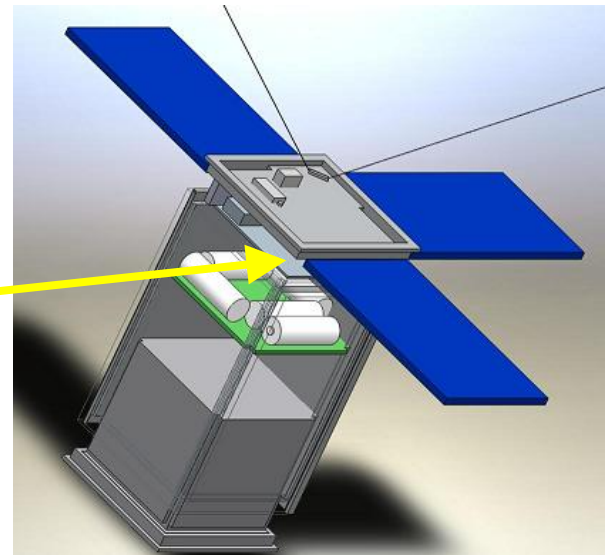
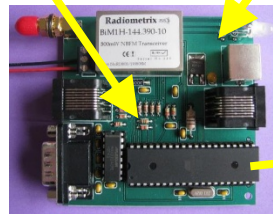

2010 Navy SERB

Operational Concept Graphic

Ground Terminal Applications Focus (force tracking and text-messaging)

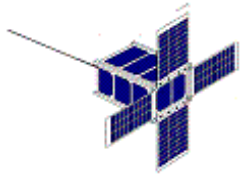

Supports Student Experimenters
School missions/movements
Theater area communications
and Emergency Response Comms

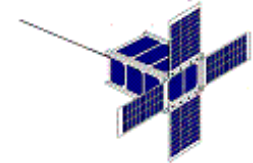

13th Co Army/Navy Football Run
Comms by USNA Radio Club
W3ADO



The Yard Patrol Craft

Education
Force
Multiplier!

Ground Terminal Applications Focus

Supports Student Experimenters world wide



OR

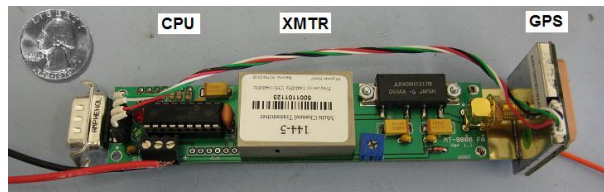

OR

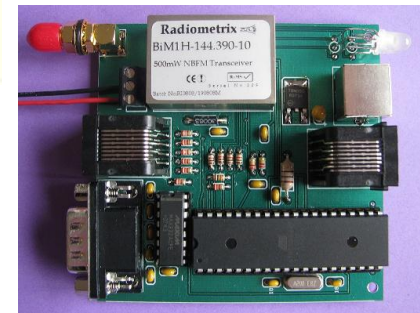

Mission Background

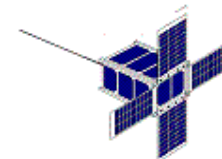

Psat Xponder Mission (Remote Data Relay)

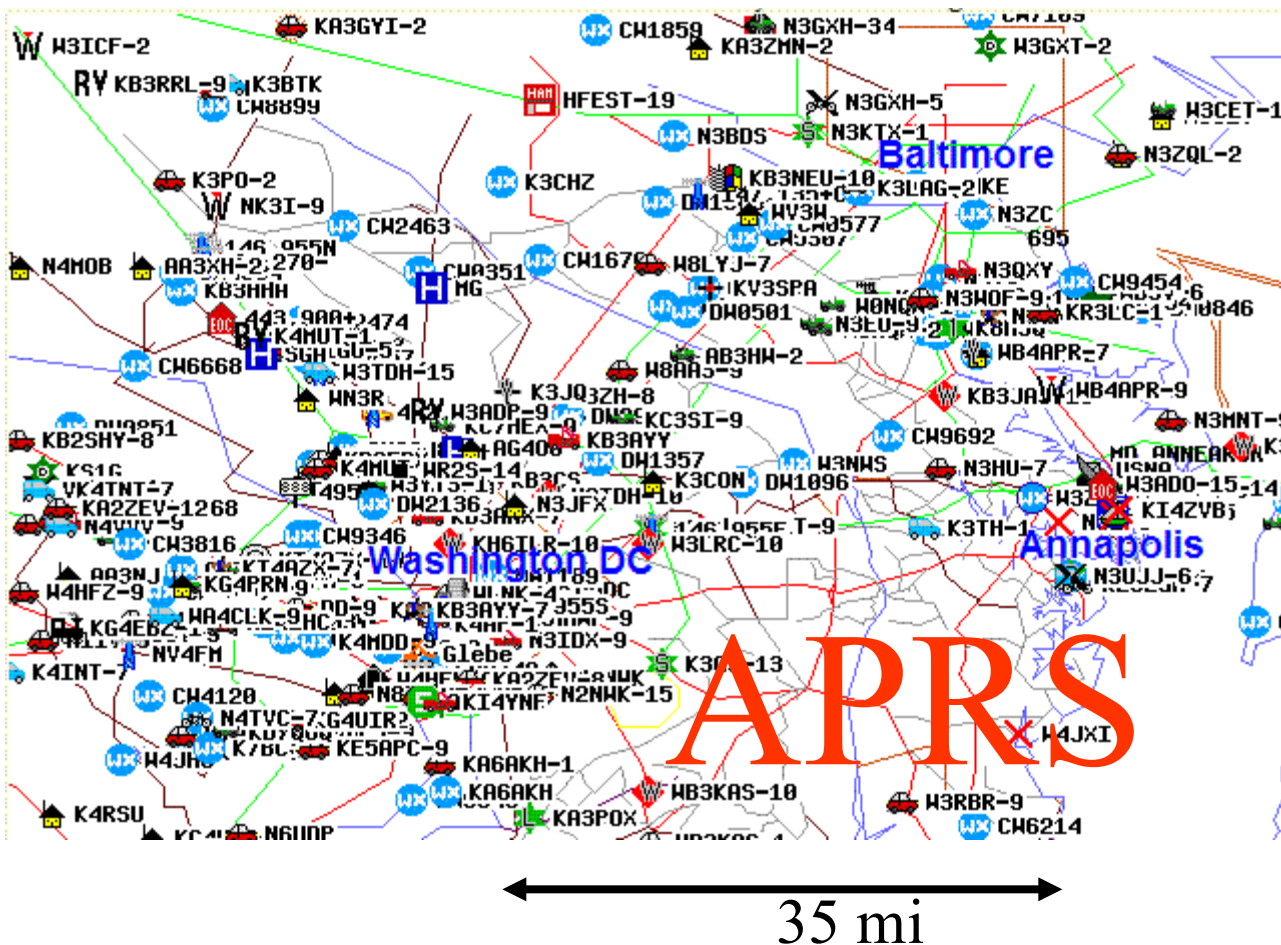

FOCUS:

**“Network
Centric”**

&

**Remote Sensor
Experiments**

300 stations
In 35 miles

Find any station - http://aprs.fi/WB4APR*

Ground Terminal Applications Focus

Tactical Situational Awareness and Text Messaging

Last 100 stations!

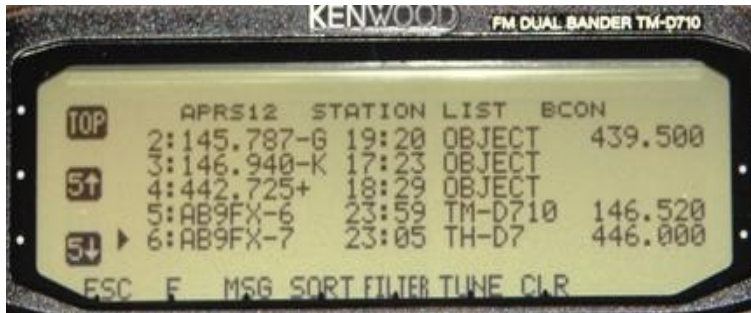

Direction & Distance

Frequency and Tone

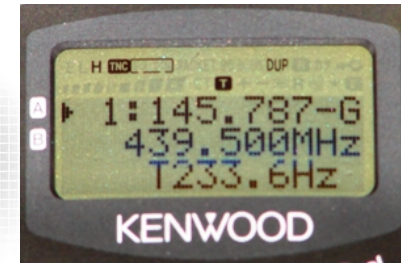

Example Situational Awareness (in SLC Utah)

27 users in S.L.C

map.findu.com/N7RKB*



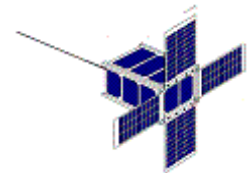

P-SAT Data Exfiltration Background

- Psat transponder can draw from thousands of experimenters for large scale loading experiments and other SERB experiments.



The Flashline Mars Arctic Research Station (FMARS) 2002 Field Season

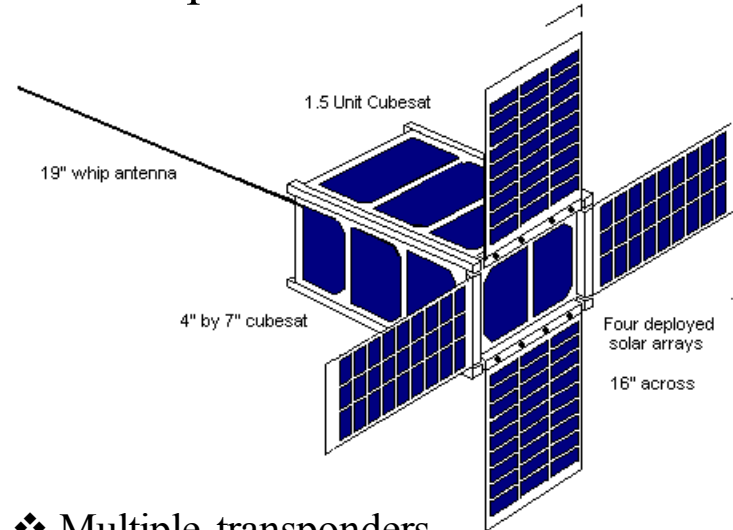
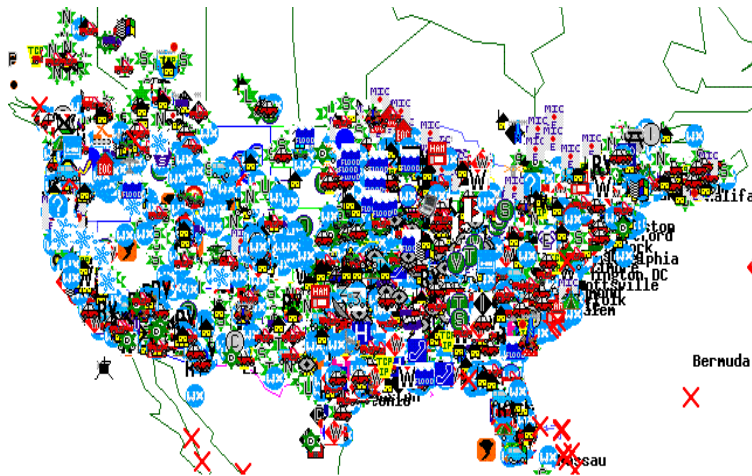

- ❖ Multiple transponders on smaller picosats can form a constellation for greater coverage and reduced latency.

- Not only the sensors and users exist, but the global Internet collection and distribution system also exists from PCSAT1 & 2.

Small Platform Minimum Satcom (SPMS) Background

Ground Terminal is Walkie-Talkie, and Palm Pilot



Psat Global Internet linked Comms Network

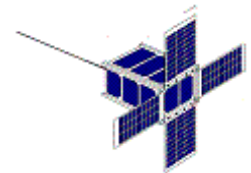

Global APRS Real-Time Connectivity (End-to-End Everywhere)

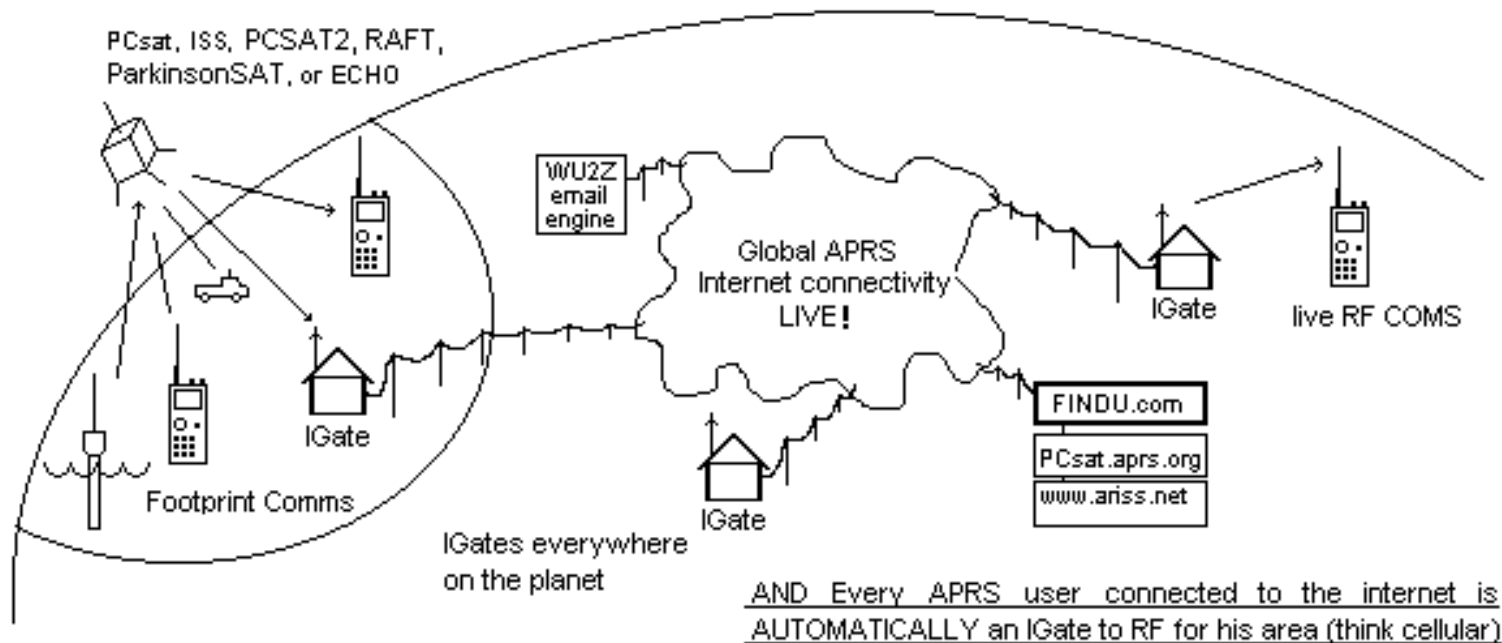

APRS Global Packet Radio Network

Internet Linked for live Communications

Automatic Packet Reporting System

APRS Experiment Data Access (via internet)

http://map.findu.com/wb4apr* to see data on ANY experiment in the world

APRS Stations Near WB4APR-9 (last 240 hours)

















Google™

findU links for WB4APR-9

- Nearby APRS activity
- Raw APRS data
- Messages
- Nearest tide stations
- Metric units
- Nautical units
- Display track
- APRS Map Manager coverage
- NexRAD Radar
- Topographic map
- Aerial Photo
- APRSWorld map
- hide Google Maps

External links for WB4APR-9

- QRZ Lookup
- MSN map (North America)
- MSN map (Europe)
- MSN map (world)
- TopoZone

Call	callbook	msg	wx	lat	lon	distance	direction	Last Position
 WB4APR-9	**	**	.	39.00000	-76.50000	0.0		00:06:02:46
 VA3ADG	**	.	.	38.99717	-76.50450	0.3	SW	05:22:10:17
 WB4APR-1	**	**	.	38.99033	-76.49850	0.6	S	00:00:11:28
 WE4APR-9	**	.	.	38.98667	-76.49283	0.9	SE	00:03:23:42
 WB4APR-3	**	**	.	38.98500	-76.48550	1.3	SE	00:10:55:08
 KB3KAK-9	**	.	.	39.02567	-76.50067	1.5	N	01:00:57:40
 VA2JPN	**	.	.	38.97150	-76.49717	1.7	S	06:07:21:19
 K3FOR-8	**	**	.	39.03200	-76.50267	1.9	N	00:08:58:06
 WB1HAI-9	**	.	.	38.97067	-76.48400	2.0	SE	00:02:25:47
 N3MNT-9	**	.	.	39.02117	-76.46400	2.5	NE	06:21:14:31
 N3HU-9	**	.	.	39.01833	-76.44867	3.3	NE	00:02:18:02
 N3KNP	**	**	.	38.97233	-76.55017	3.4	SW	04:01:37:14
 W3AFE	**	**	.	39.03517	-76.45100	3.6	NE	00:02:14:24
 K3TH-14	**	.	.	38.97383	-76.56288	4.1	SW	08:23:06:24
 K3TH-3	**	.	.	38.97400	-76.56317	4.1	SW	00:00:14:52
 N3HU	**	.	.	39.04017	-76.44183	4.2	NE	00:00:01:28

* Click to see all stations on map

Based on the USNA **A**utomatic **P**acket **R**eporting **S**ystem

“Purple Force” Tracking

Map.findu.com/wb4apr*

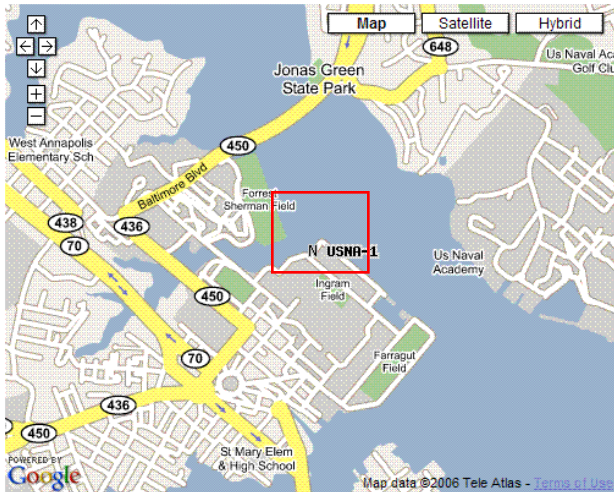

Tactical situational awareness



Where to See it ALL

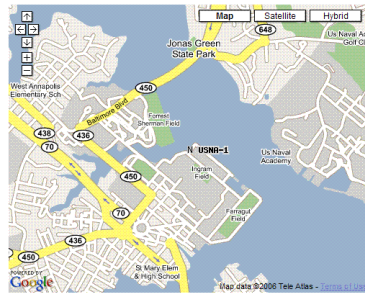

Global Comm system

<http://aprs.fi>

Findu.com Telemetry Plots

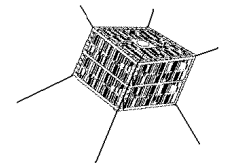

Live Example: www.aprs.org/wb4apr-15.html

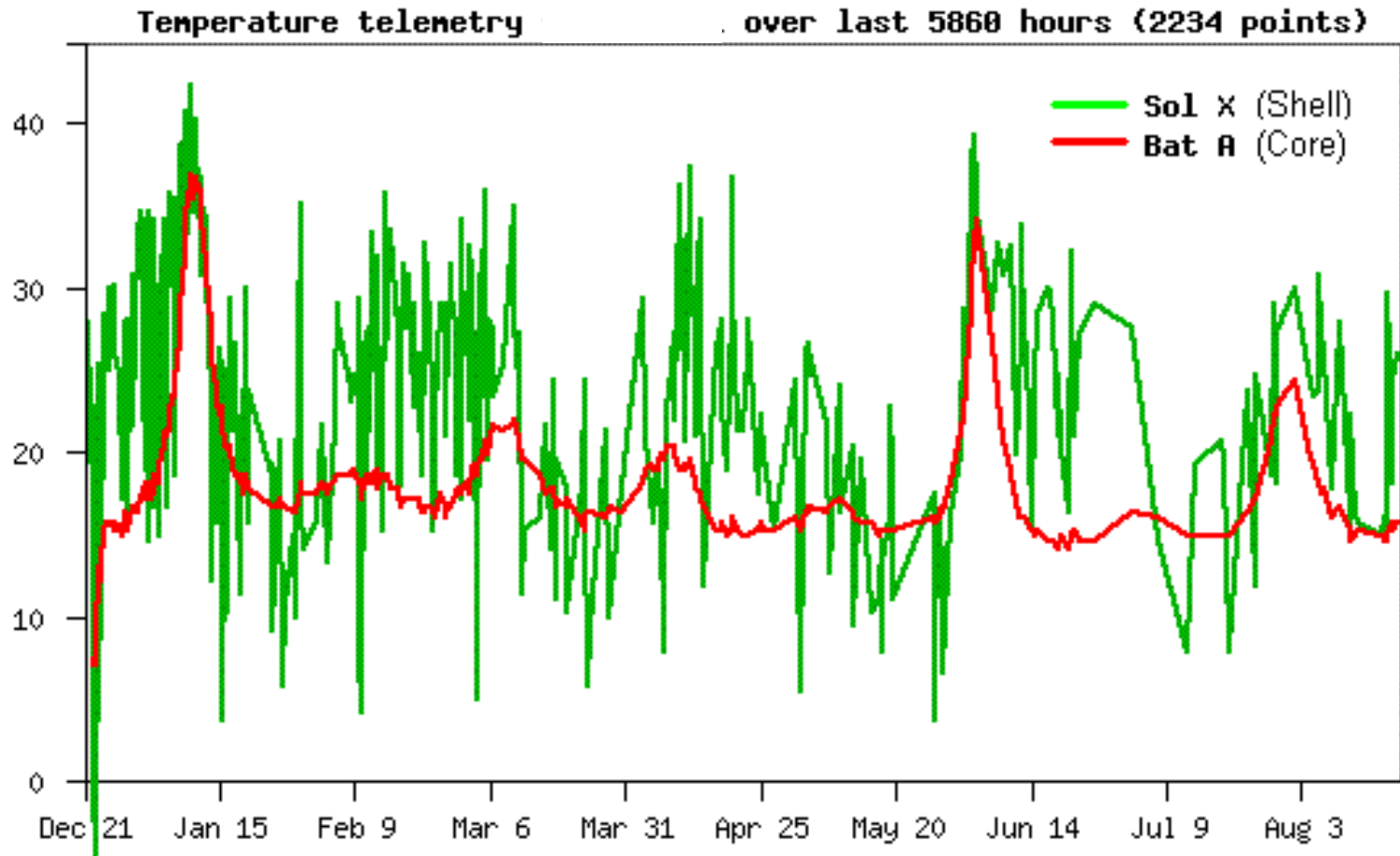

Example Remote Sensors using **APRS** Protocol



Very Simple

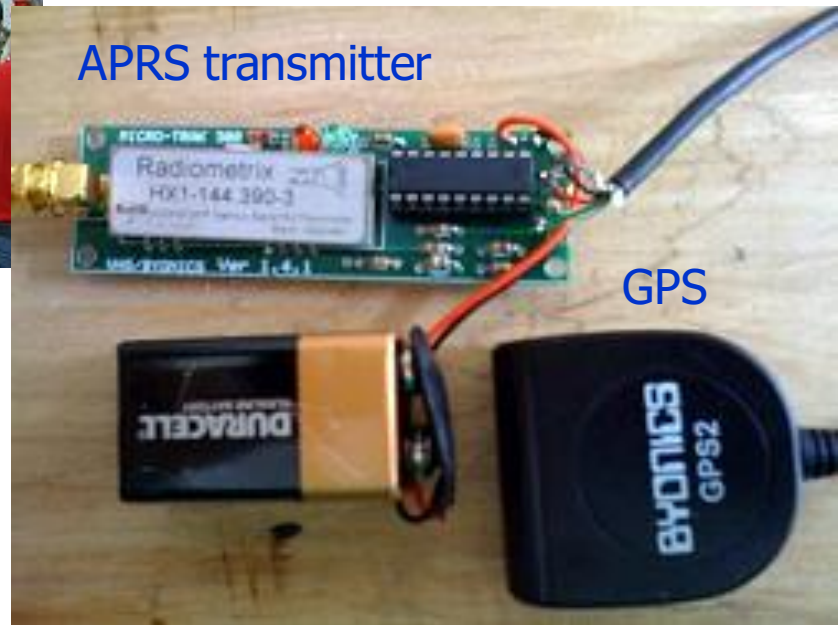

Based on the **USNA Automatic Packet Reporting System**

Universal Ham Radio Text Messaging Initiative

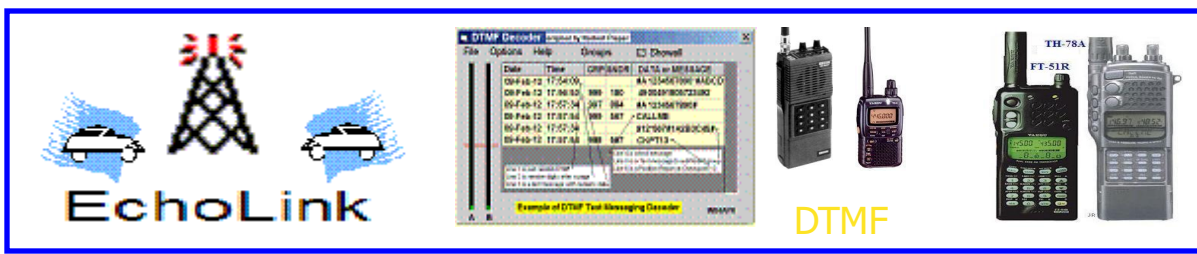

Send/RX anytime, anywhere, any device by callsign

26 separate systems!

Sensor Buoy Baseline (prototype)

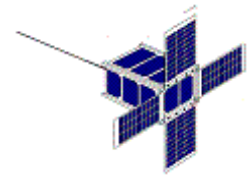

Naval Academy Student Project

- * If free-floating, do not disturb.
- * If aground, move to deep water and advise bruninga@usna.edu
- * If later than 30 Nov 2006, recover and advise above.



2006 15:1 reduction

2008

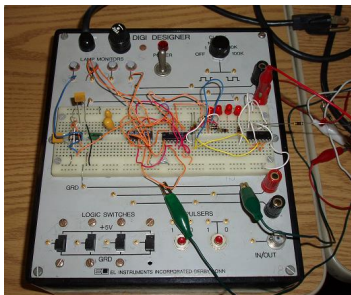
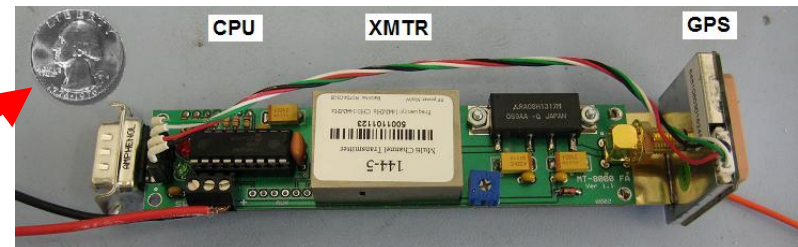

See Buoy Location and Telemetry at <http://www.ew.usna.edu/~bruninga/buoy4.html>

DOD Synergy with Educational Experimenters

Based on the USNA Automatic Packet Reporting System

APRS Data Experiment in F-16 Aircraft



“Purple Force” Tracking

Map.findu.com/w3ado*

Tactical situational awareness



APRS (Psat Transponders) in Space

- 2001 **PCSAT-1** Prototype Comm (semi-operational)
- 2006 **PCSAT2** on ISS (returned after 1 year)
- 2007 **ANDE** de-orbited in 1 year
- 2008 **RAFT** de-orbited in 5 months
- 2007 **Present ISS** semi-operational due crew settings



Experimenters need a continuous Transponder in Space

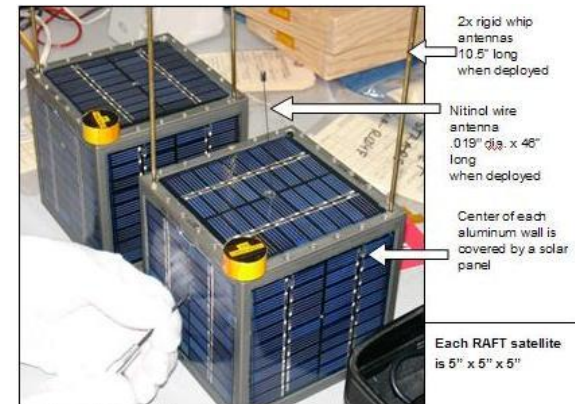
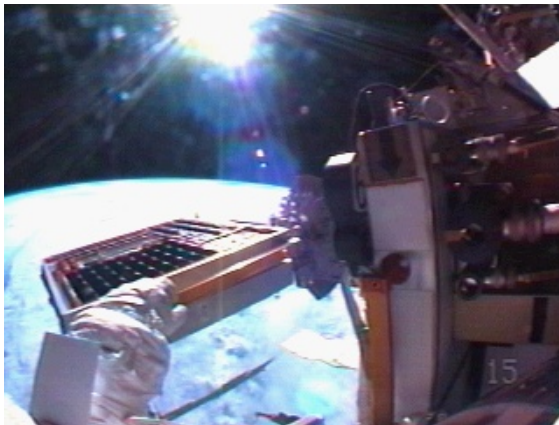

2x rigid whip antennas
10.5" long
when deployed

Nitinol wire antenna
.019" dia. x 48"
long
when deployed

Center of each
aluminum wall is
covered by a solar
panel

Each RAFT satellite
is 5'' x 5'' x 5''

APRS space frequency is published as 145.825

See live downlink on <http://pcsat.aprs.org> and www.ariss.net

Huge reduction from Previous APRS transponders on PCSAT's 1,2, ANDE and RAFT missions



Now reduced 18:1
in volume/mass

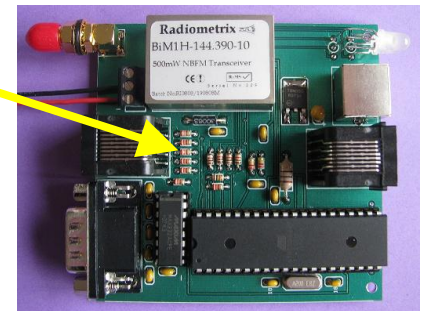

Mission: Remote Data Relay, Data Exfiltration, Remote Sensor Relay

Benefit: Support Space Education on the ground through space applications and student experimental access

Hardware: VHF simplex data Xsponder 145.825 MHz

Size/Mass: < 10 cu.in (1 PCB 3.4" square), <0.1kg

Power: < 1W orbit average, 5 volts.

Integration Requirement: Simply, on/off (or *)

Structure Impact: Needs 19" thin wire whip antenna (1 cu.in)

Benefit to Spacecraft: High visibility to worldwide educational institutions, fosters collaboration, orders of magnitude greater student experimental access to space systems (ground segment). * Independent back-up telemetry command/ control channel, RS232 serial data, 16 on/off discretes, backdoor reset capability. Worldwide Telemetry Beacon access via global station network.

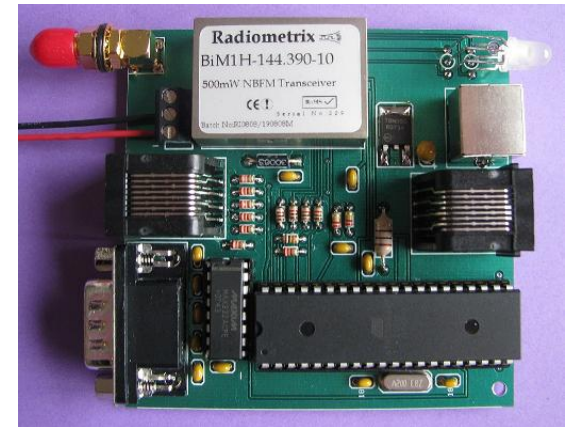

Constellation Operation of USNA Satellites

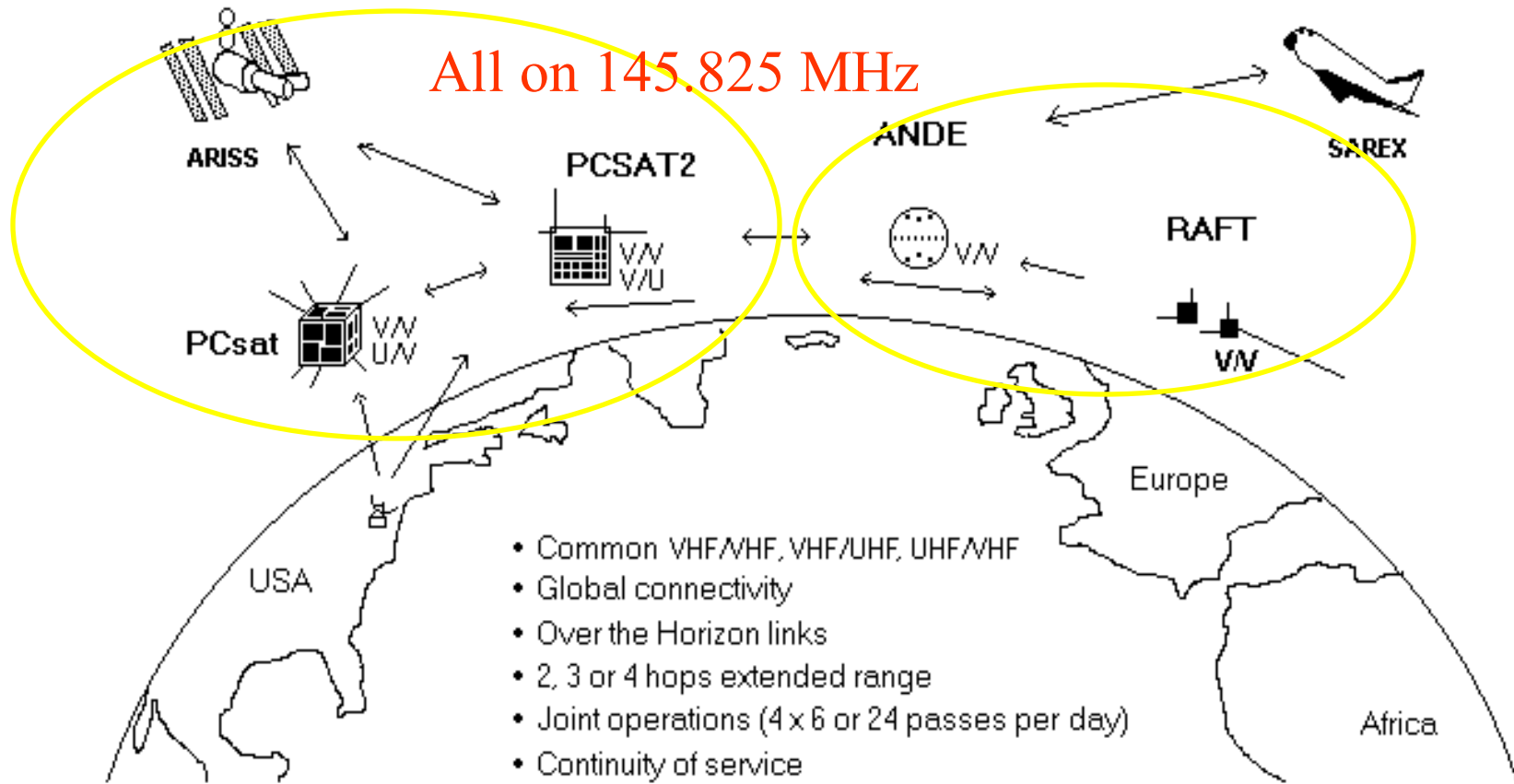

WB4APR

See live downlink on <http://pcsat.aprs.org> and www.ariss.net

Dual Hop Operations with PCSAT-1 and PCSAT2:

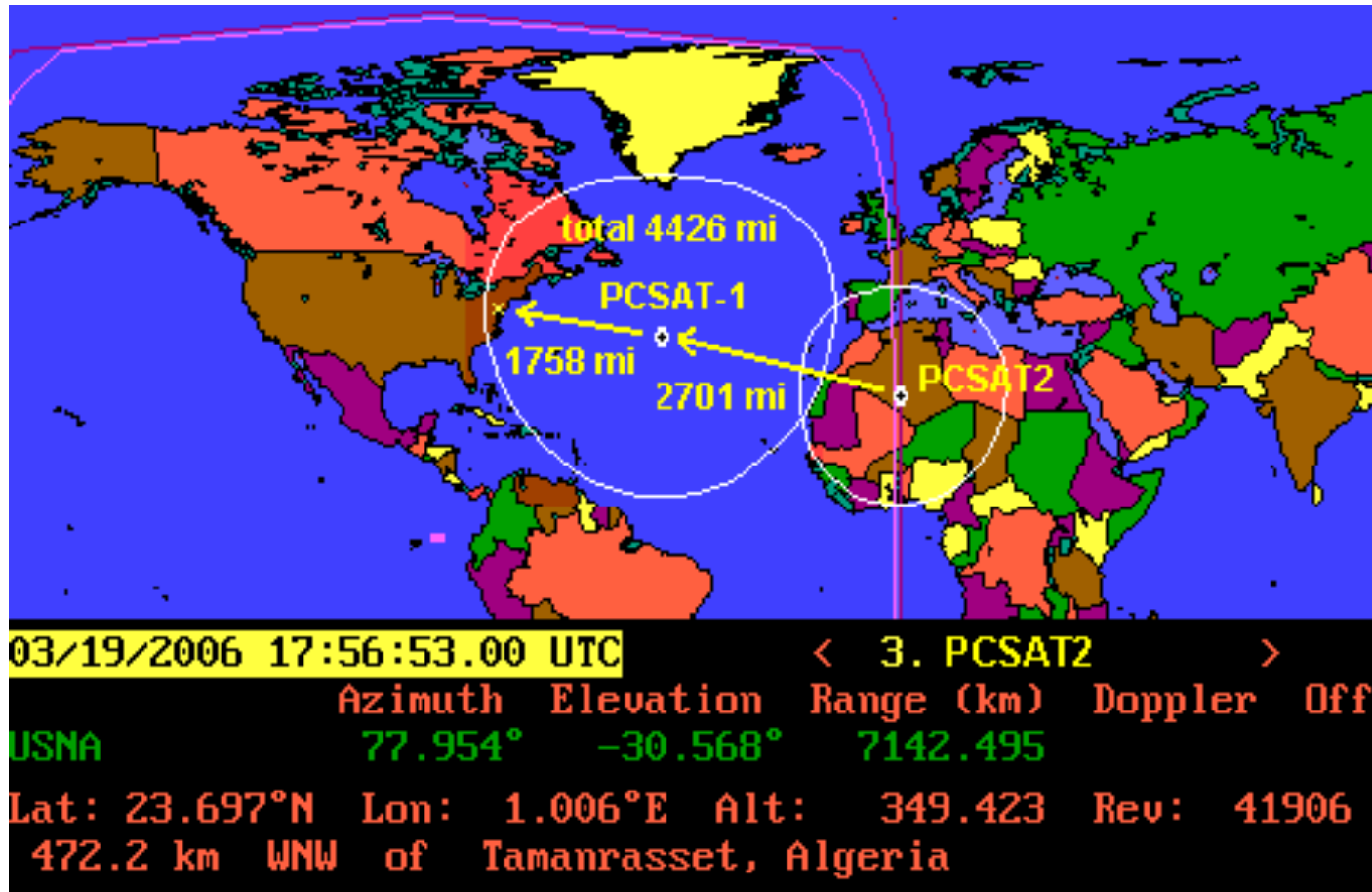

During the March 2006 joint PC1<=>PC2 operations period, numerous dual hop elemetry and user packets were observed. This telemetry packet from PCSAT2 is just about as far as we can get with satellite-to-satellite-to USNA. Notice how few European or USA users were in the footprint making it more probable that PCSAT-1 could hear PCSAT2's signal. WB4APR

Dual Satellite 2-hop links

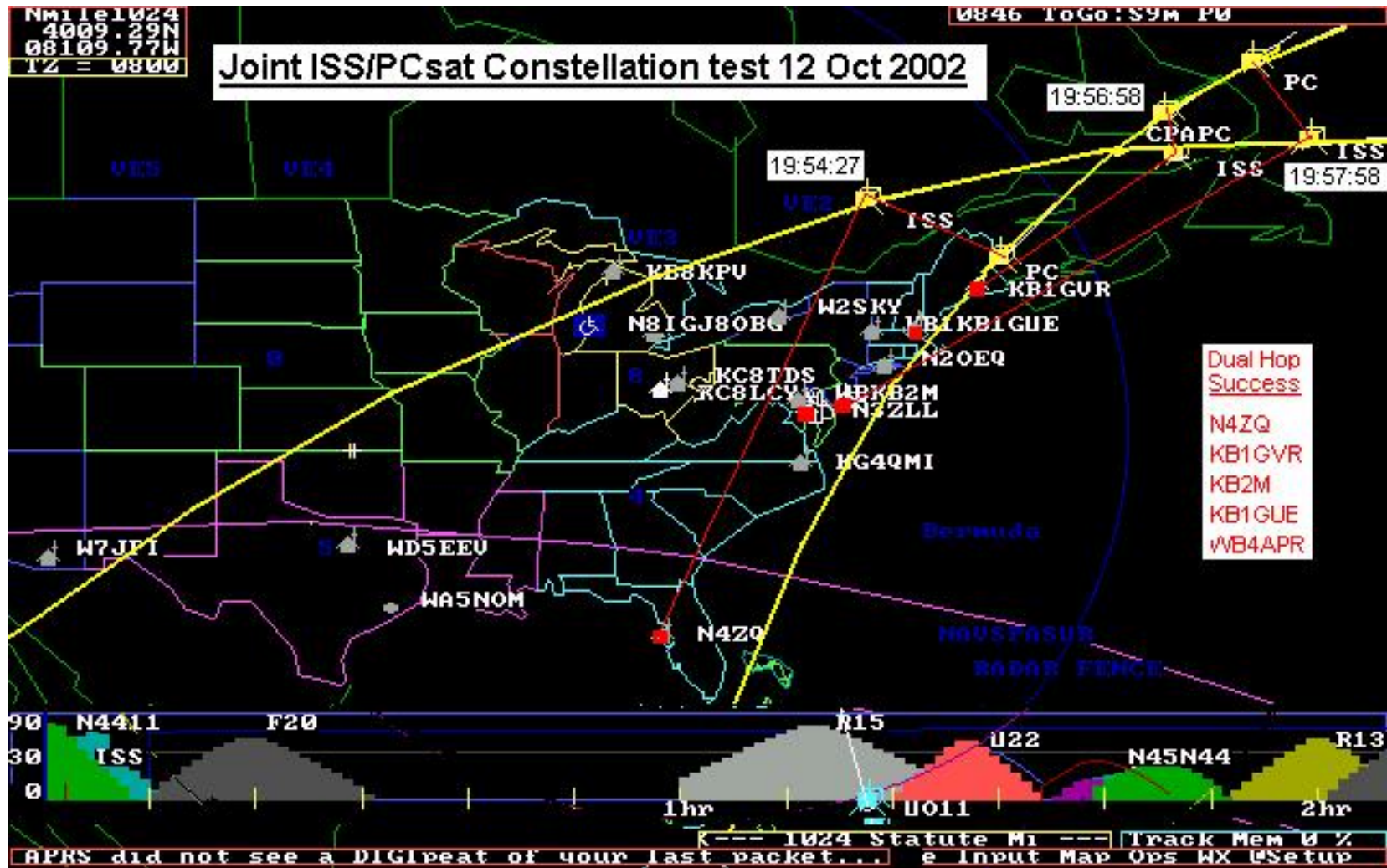

Global Volunteer Groundstations

feed live downlink into Internet



Sensor Buoy Baseline PCSAT validates our links

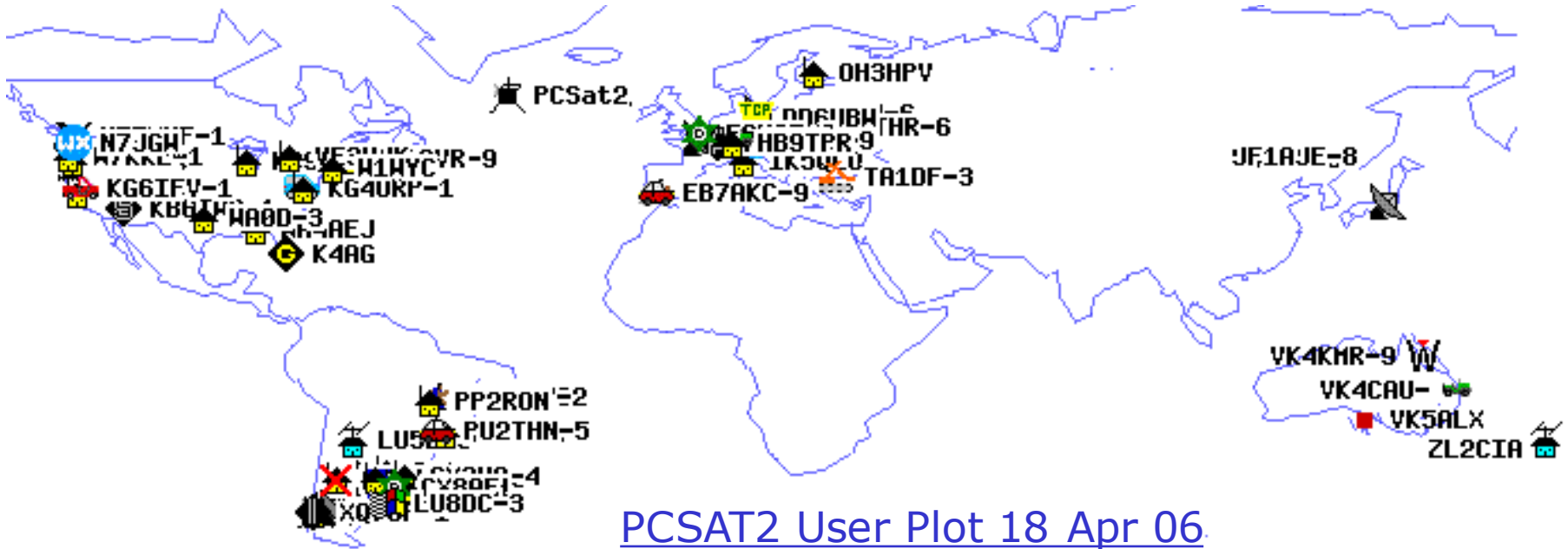

PCSAT2 User Plot 18 Apr 06

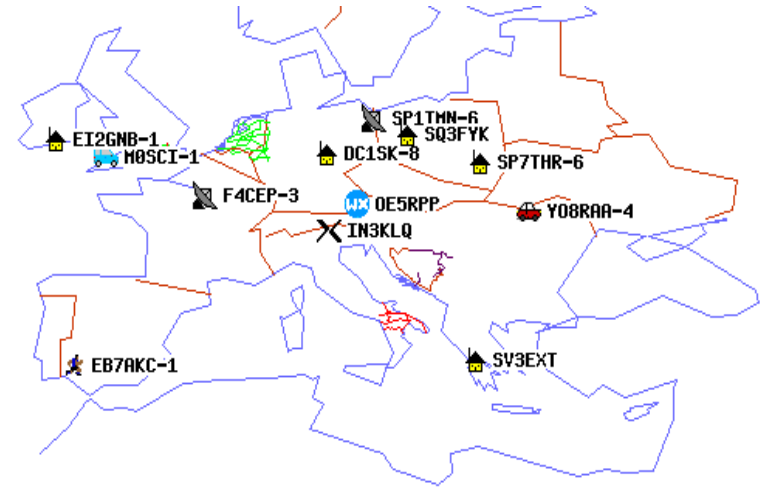
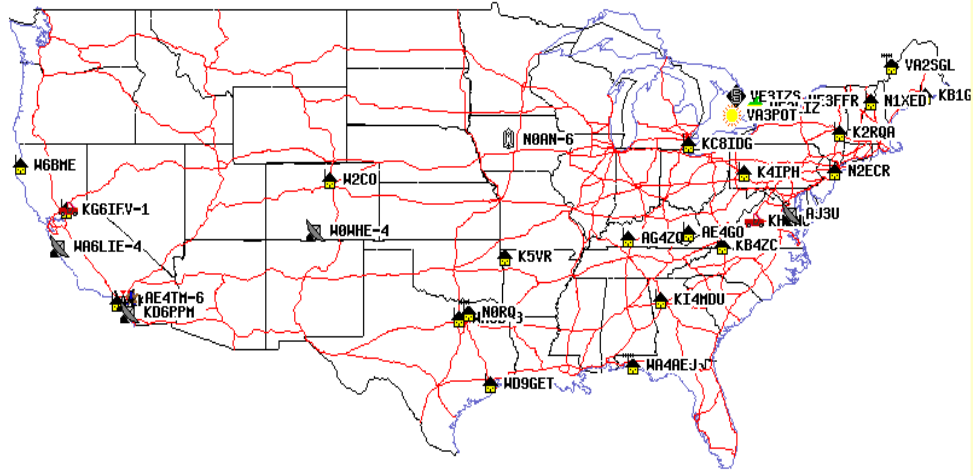

Sensor Buoy Baseline Test

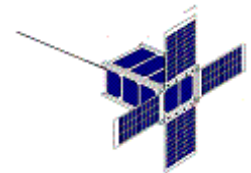

Number of Buoy Packets Received Per Day via PCSAT-1 and PCSAT2

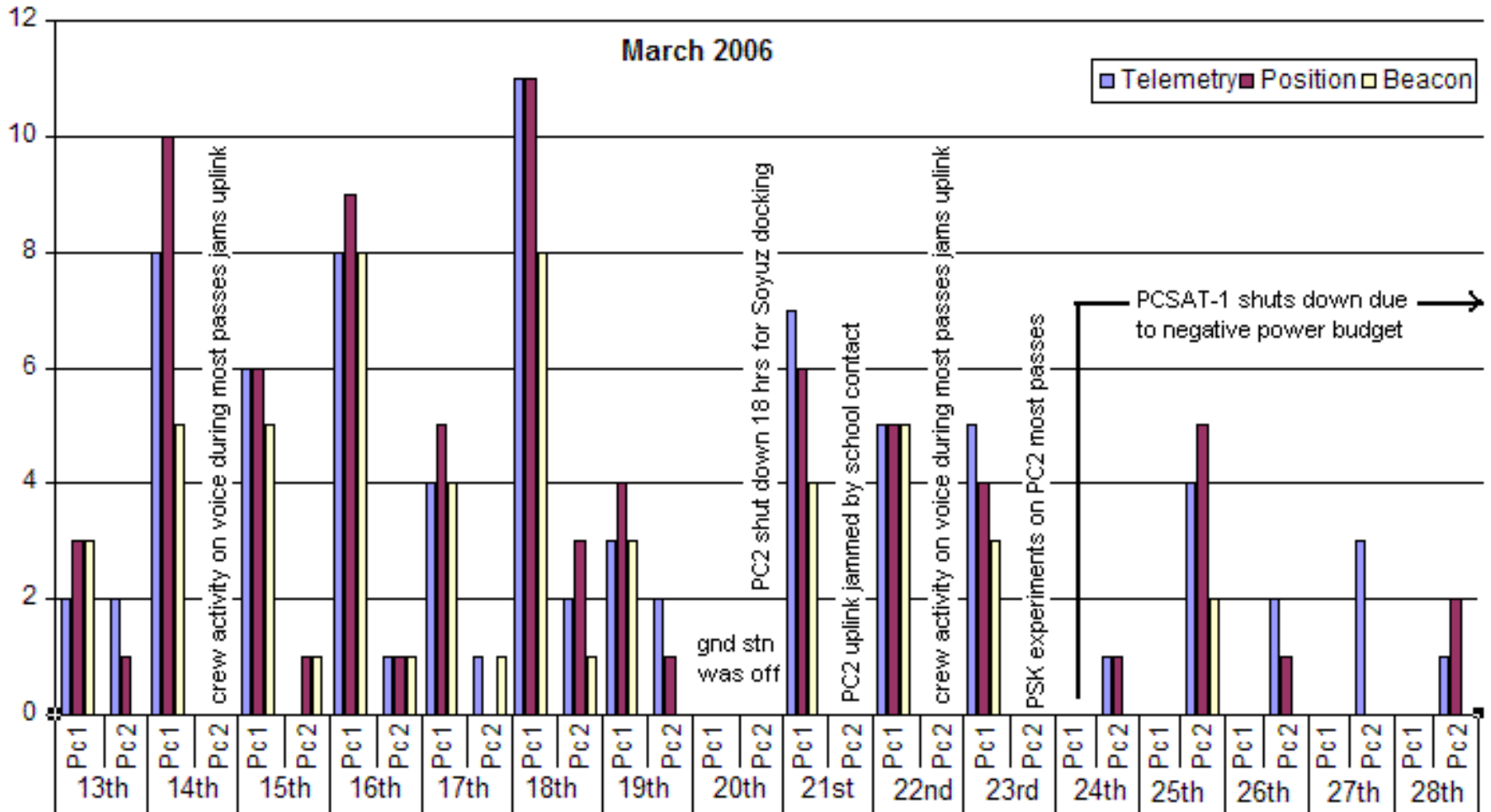

Prototype Buoy Data

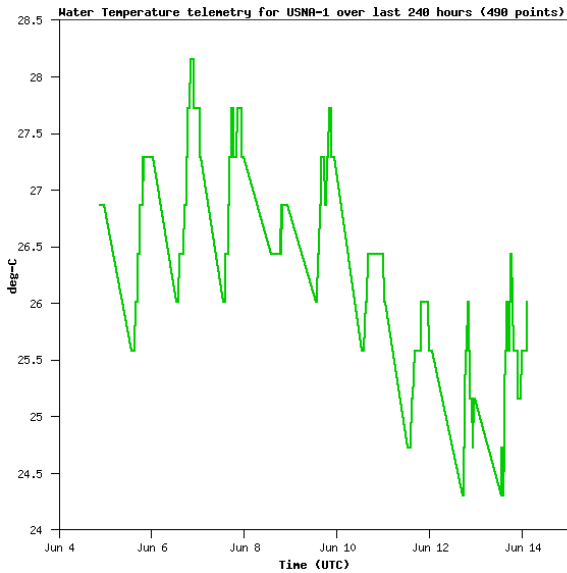
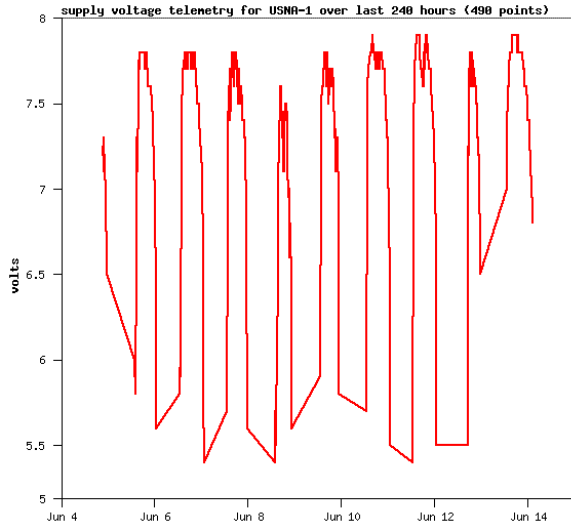

Google for
“USNA Buoy”
Select USNA-1
(or Buoy4)



2010 Navy SERB

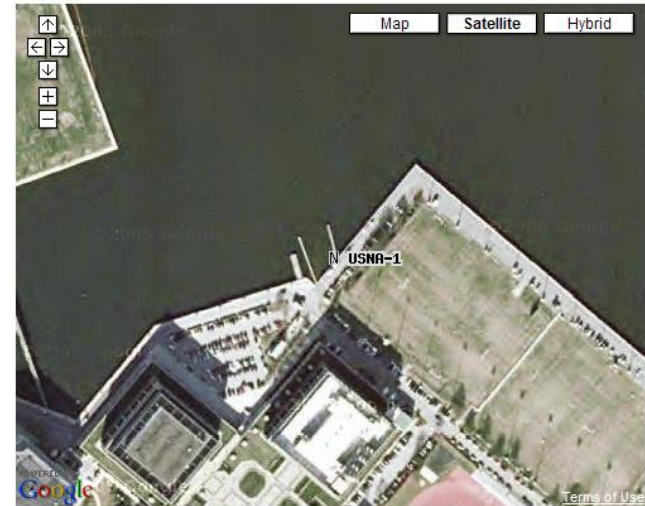
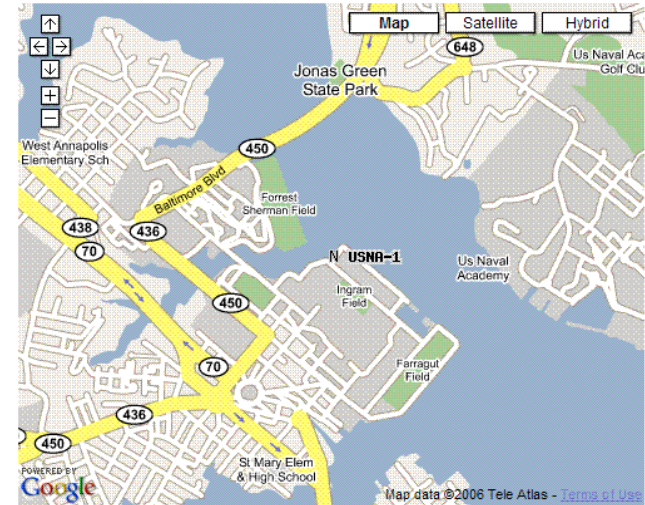

Questions?

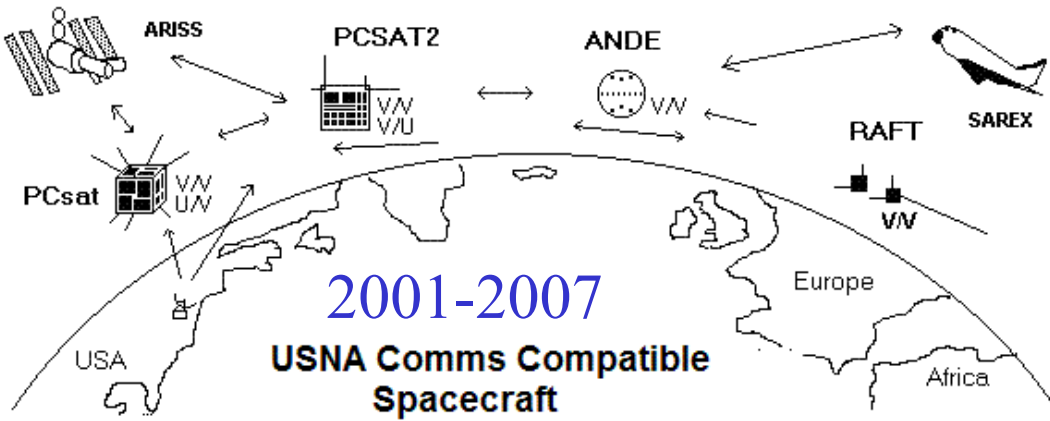

2006



2007

2009

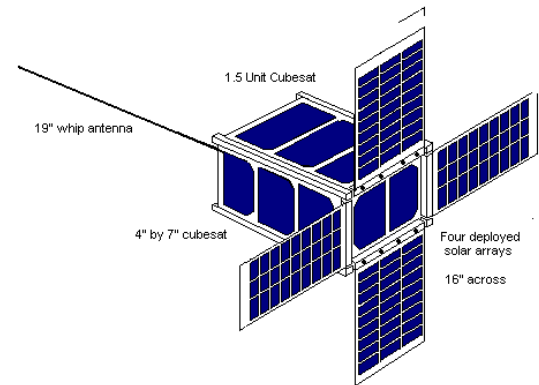

2010 Navy SERB